

R&S®FS-K76

TD-SCDMA Basis Stations Test

Software Manual



1300.7304.42 - 05

© 2014 Rohde & Schwarz GmbH & Co. KG

Muehldorfstr. 15, 81671 Munich, Germany

Phone: +49 89 41 29 - 0

Fax: +49 89 41 29 12 164

E-mail: info@rohde-schwarz.com

Internet: <http://www.rohde-schwarz.com>

Subject to change - Data without tolerance limits is not binding.

R&S® is a registered trademark of Rohde & Schwarz GmbH & Co. KG.

Trade names are trademarks of the owners.

The following abbreviations are used throughout this manual:

R&S®FS-K76 is abbreviated as R&S FS-K76

Contents

1	TD–SCDMA Base Station Test Application Firmware R&S FS-K76	7
2	Installing and Enabling Application Firmware	8
2.1	Installation	8
2.1.1	Enabling	8
3	Getting Started	9
3.1	Generating TD-SCDMA signal with R&S WinIQSIM	10
3.1.1	Basic settings in TD–SCDMA BTS mode	14
3.2	Measurement 1: Measuring signal power	15
3.3	Measurement 2: Measuring spectrum emission mask	16
3.5	Measurement 3: Measuring relative code domain power and frequency error	17
3.5.1	Setting: Synchronizing reference frequencies	17
3.5.2	Setting: Response to deviating center frequency setting	18
3.5.3	Setting: Response to wrong scrambling code	19
3.6	Measurement 4: Measuring composite EVM	19
3.7	Measurement 5: Measuring peak code domain errors	20
3.8	Measurement 6: Measuring RHO factor	21
4	Setup for Base Station Tests	22
4.1	Standard test setup	22
4.2	Default setting	23
5	Menu Overview	24
6	Configuration of TD-SCDMA Measurements	27
6.1	Measurement of channel power	28
6.2	Measurement of adjacent channel power - ACLR	31
6.3	Menu MEAS - MULT CARR ACLR	39
6.4	Checking signal power - SPECTRUM EM MASK	44
6.4.2	3GPP Norm: Spectrum Emission Mask	46
6.4.3	TSM Norm: Spectrum Emission Mask	47
6.5	Measurement of bandwidth occupied by signal - OCCUPIED BANDWIDTH	51
6.6	Signal power versus time - POWER VS TIME	55
6.7	Signal statistic	57
6.8	Code domain measurements on TD–SCDMA signals	63

6.9	Presentation of evaluations - RESULTS.....	65
6.10	Configuration of application firmware - SETTINGS	88
6.11	Frequency setting – <i>FREQ</i> key.....	93
6.12	Span settings – <i>SPAN</i> key	94
6.13	Level settings - <i>AMPT</i> key	94
6.14	Marker settings - <i>MKR</i> key.....	96
6.15	Marker settings - <i>MKR</i> → key	97
6.16	Marker functions - <i>MKR FCTN</i> key.....	98
6.17	Bandwidth setting - <i>BW</i> key	99
6.18	Measurement control - <i>SWEEP</i> key	99
6.19	Measurement selection - <i>MEAS</i> key	99
6.20	Trigger functions - <i>TRIG</i> key	99
6.21	Trace settings - <i>TRACE</i> key.....	100
6.22	Display-Lines - Taste <i>LINES</i>	101
6.23	Measurement screen settings - <i>DISP</i> key	102
6.24	Storing and loading unit data - <i>FILE</i> key	102
6.25	Preset of device - <i>PRESET</i> key.....	102
6.26	Calibration of device - <i>CAL</i> key.....	102
6.27	Setup of device - <i>SETUP</i> key	102
6.28	Printing - <i>HCOPY</i> key	102
7	Remote Control Commands	103
7.1	CALCulate:FEED subsystem.....	103
7.2	CALCulate:LIMit: ESPectrum subsystem	104
7.3	CALCulate:MARKer subsystem	107
7.4	CALCulate:PEAKsearch PSEarch subsystem.....	110
7.5	CONFigure:CDPower subsystem.....	111
7.6	INSTrument subsystem.....	117
7.7	SENSE:CDPower subsystem	118
7.8	SENSE:Power subsystem	125
7.9	TRACe subsystem	132
7.10	STATus:QUEStionable:SYNC register	139
7.11	Table of softkeys with assignment of IEC/IEEE bus commands.....	140
7.11.1	<i>MEAS</i> key or <i>MEAS</i> hotkey	140
7.11.2	RESULTS hotkey or CODE DOM ANALYZER softkey	145
7.11.3	CHAN CONF hotkey	147
7.11.4	<i>SETTINGS</i> hotkey	148

8	Checking Rated Specifications	149
8.1	Measuring equipment and accessories	149
8.2	Test sequence	150
9	Glossary	153
10	Index	155

1 TD-SCDMA Base Station Test Application Firmware R&S FS-K76

When configured with the Application Firmware R&S FS-K76, the analyzer performs code domain power measurements on forward link signals (base station). The measurements are based on the 3GPP (Third Generation Partnership Project) standard or alternatively on the CWTS-TSM standard (China Wireless Telecommunication Standard).

The basic standards are 3GPP TS 25.142 "Base Station Conformance Testing (TDD)", version V5.5.0, 3GPP TS 25.221 "Physical channels and mapping of transport channels onto physical channels (TDD)", version V5.5.0 and CWTS TSM 11.21 "Base Station System (BSS) equipment specification", version V3.1.0. When TD-SCDMA specifications are mentioned in the document, this standard is meant.

In addition to the measurements specified by the TD-SCDMA standard in the code domain, the application firmware features measurements in the spectral range such as channel power, adjacent channel power, occupied bandwidth and spectrum emission mask with predefined settings.

2 Installing and Enabling Application Firmware

2.1 Installation

If the Application Firmware R&S FS–K76 is not yet installed on the unit, a firmware update is necessary. This has already been done in the case of installation at the factory.

You must install appropriate basic firmware on the analyzer to enable installation of the application firmware. Refer to the release notes of the current Application Firmware R&S FS–K76 for compatible versions.

If the basic firmware has to be updated, start the update with the floppy disks containing the basic firmware by *SETUP → NEXT → FIRMWARE UPDATE*.

If the correct basic firmware is installed, start the update for the application firmware from the floppy disks containing the Application Firmware R&S FS–K76 by the same operation *SETUP → NEXT → FIRMWARE UPDATE*.

After installation of the application firmware, you must enable it as described below.

2.1.1 Enabling

The Application Firmware R&S FS–K76 is enabled in the *SETUP → GENERAL SETUP* menu by entering a keyword. The keyword comes with the application firmware. If the application is installed at the factory it will already be enabled.

Options

The *OPTIONS* softkey opens a submenu in which you can enter the keywords for the application firmware. The existing applications are displayed in a table that opens when you enter the submenu.

INSTALL OPTION

The *INSTALL OPTION* softkey enables entry of the keyword for an application firmware.

A keyword can be entered in the entry field. If the keyword is valid, the message *OPTION KEY OK* is displayed and the application firmware is entered in the *FIRMWARE OPTIONS* table.

If an invalid keyword is entered, *OPTION KEY INVALID* is displayed.

If the version of the application firmware and that of the basic firmware are not compatible, you see a corresponding message. In this case, follow the instructions in the above chapter "Installation".

3 Getting Started

The following chapter explains basic TD-SCDMA base station tests using a setup with the Signal Generator R&S SMIQ as the device under test. It describes how to avoid operating and measuring errors by correct default settings.

The measurement screen is presented in Chapter 5 for the different measurements.

Your attention is drawn to important settings exemplifying how to avoid errors during measurement. The correct setting is followed by a demonstration of the effect of an incorrect setting. The following measurements are performed:

Measurement 1: measuring signal spectrum

Measurement 2: measuring spectrum emission mask

Measurement 3: measuring relative code domain power and frequency error

Setting: center frequency

Setting: scrambling code

Measurement 4: measuring composite-EVM

Measurement 5: measuring peak code domain error

Measurement 6: measuring RHO factor

TD-SCDMA raw data are created with the R&S WinIQSIM Software and loaded in the arbitrary waveform generator of the R&S SMIQ.

Measurements are performed with the following units and accessories:

- Spectrum Analyzer R&S FSU, R&S FSP or Signal Analyzer R&S FSQ with Application Firmware R&S FS-K76 base station test for TD-SCDMA.
- Vector Signal Generator R&S SMIQ with hardware options B11 Data Generator, B20 Modulation Coder and B60 Arbitrary Waveform Generator plus firmware version 5.70 or higher with enabled option K14 TD-SCDMA and R&S SMIQ-Z5 PARADATA BNC Adapter for an external trigger signal.
- A PC that is either connected to the R&S SMIQ by a serial cable or has an IEC/IEEE bus card and is connected to the R&S SMIQ by an IEC/IEEE bus cable. Installed on this PC is the R&S WinIQSIM Software 4.00 or higher. You can download this software from the Rohde & Schwarz Internet site <http://www.rohde-schwarz.com>.
- One coaxial cable, 50 Ω , approximately 1 m, N connector.
- Two coaxial cables, 50 Ω , approximately 1 m, BNC connector.

3.1 Generating TD-SCDMA signal with R&S WinIQSIM

You can download the R&S WinIQSIM Software from <http://www.rohde-schwarz.com> and install it on a PC. Using the R&S WinIQSIM Software you can generate TD-SCDMA signals and then transfer them to an R&S SMIQ or R&S AMIQ. In what follows you learn how to generate a test signal to TD-SCDMA specifications. You are assumed to be using R&S WinIQSIM version 4.00 or higher.

Start and select standard:

Start WinIQSIM.exe.

In the File menu select New and in the following list TD-SCDMA. The Block Diagram - TD-SCDMA dialog appears.

Select TD-SCDMA Configuration to configure the TD-SCDMA signal and the following dialog opens:

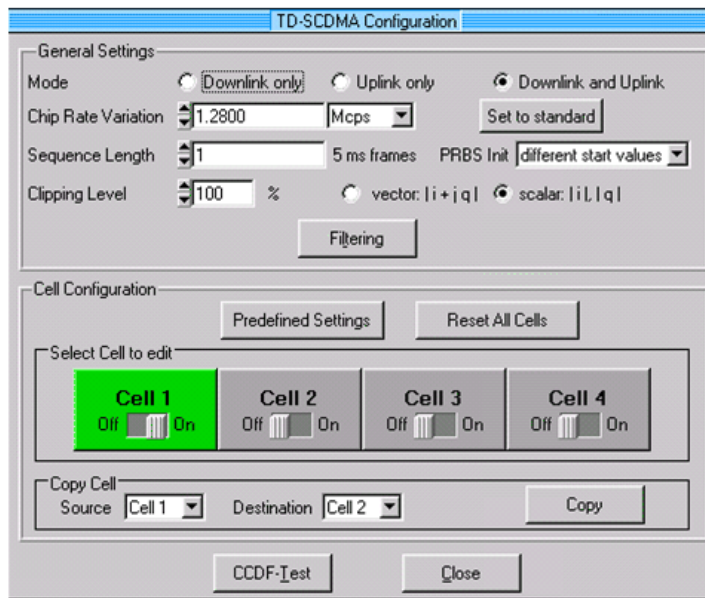

Figure 1 R&S WinIQSIM - TD-SCDMA configuration

Set transmit filter:

Select Filtering to configure the TD-SCDMA transmit filter. Increase Impulse Length to 120.

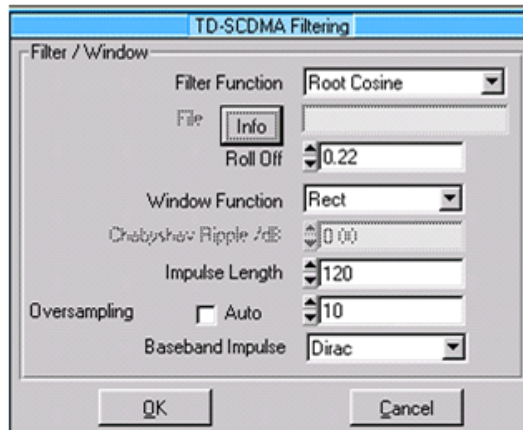

Figure 2 R&S WinIQSIM - transmit filter settings

Configure subframe:

Set as follows in **TD-SCDMA Cell Configuration** for a signal with eight channels of the same power in each of the slots 4, 5 and 6. This model is specified for some tests to TD-SCDMA standard. For synchronization you must also activate channel 1.16 in slot 0. As a rule this will be P-CCPCH.

The **Scrambling Code** must be kept on 0. Set **Mode** to **Downlink only** and select **Cell 1** to edit.

Slots 0, 4, 5 and 6 must be **On**:

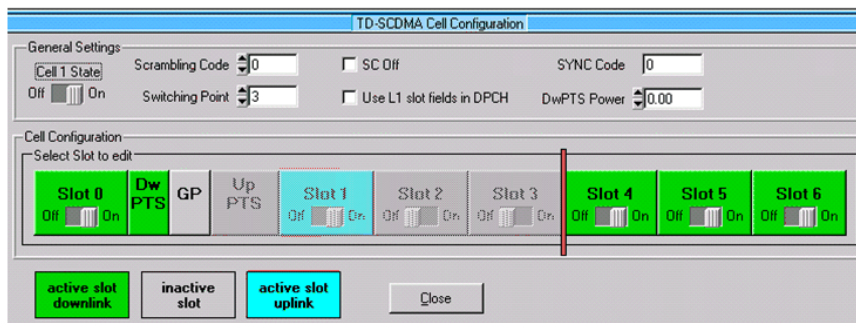

Figure 3 R&S WinIQSIM - subframe configuration

Set channels:

For synchronization of the Application Software R&S FS-K76, channel 1.16 in slot 0 must be active. This corresponds to the R&S WinIQSIM settings gross data rate: 17.6 kbps (SF 16) and Spr. Code 0. The MA Shift should be set to 120 for a valid code/midamble allocation. The wrong midamble only influences the channel table, and has no effect on the other measurements or synchronization. Other channels in slot 0 are not activated. After completing your settings, normalize the power of the channels by clicking on **Adjust Total Power to 0 dB**.

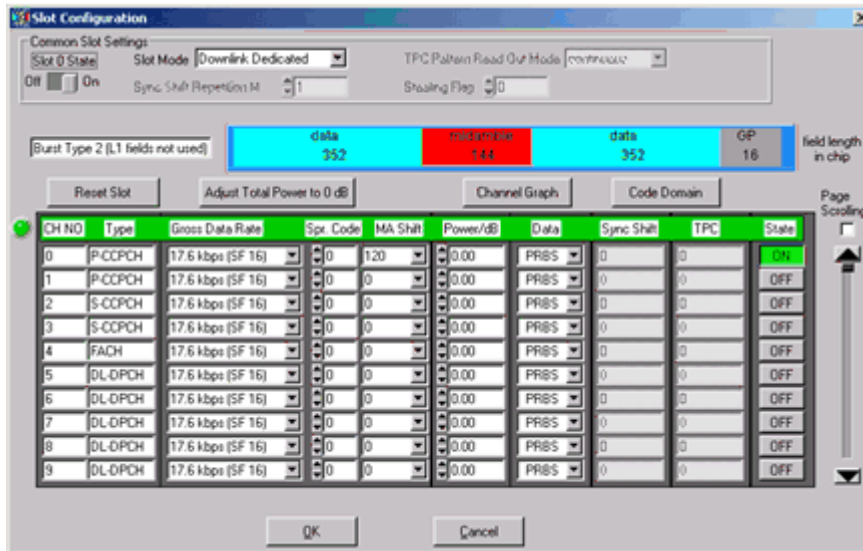

Figure 4 R&S WinIQSIM - channel settings in slot 0



The MA shift parameter in R&S WinIQSIM relates directly to the number of bits by which a basic midamble is cyclically shifted. This parameter does not correspond to the midamble shift parameter in TD-SCDMA specifications and in the Application Firmware R&S FS-K76 base station test for TD-SCDMA.

In each of the slots 4, 5 and 6, activate eight data channels, each with 1/8 of the total power. Allocate each channel a MA shift of 48, which corresponds to the midamble m(8) and produces a valid Common-Midamble-Allocation. After completing your settings, normalize the power of the channels by clicking on **Adjust Total Power to 0 dB**.

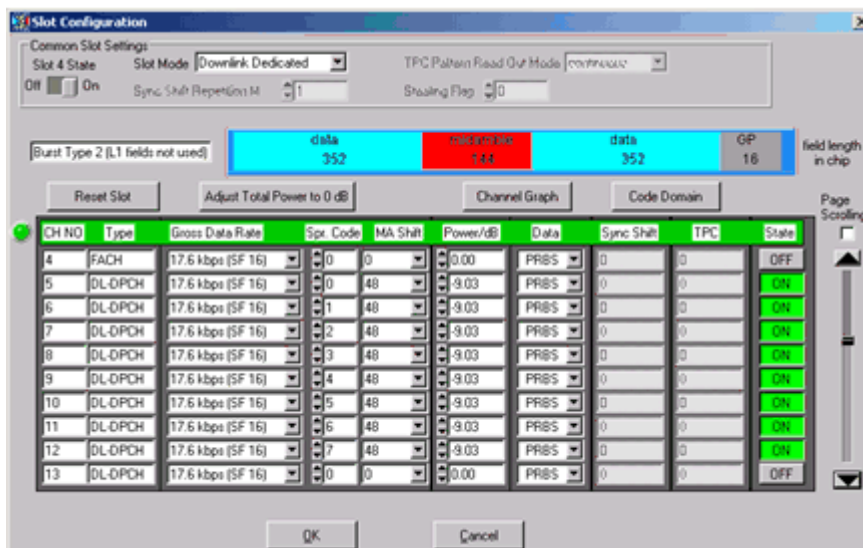

Figure 5 R&S WinIQSIM - channel settings in slots 4-6

Define trigger settings:

Now you have to set the trigger settings in the **SMIQ** menu, item **Trigger Output**.

Current Mode: Restart Clock (SEQUENCE) is defined for **Mode 1**. The trigger at the subframe limit then appears every 5 ms on TRIG1 of the R&S SMIQ Z5 BNC Adapter.

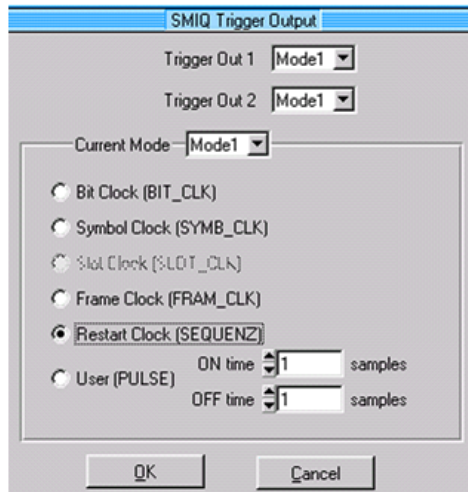

Figure 6 R&S WinIQSIM - trigger settings

Save and transfer to R&S SMIQ:

Use **File|Save Settings As** to save this TD-SCDMA configuration as a file named 'TDS_BS.IQS'.

Connect the R&S SMIQ either serially or by an IEC/IEEE bus card and IEC/IEEE bus cable, and load the generated signal to the R&S SMIQ under the name 'TDS_BS' in the **SMIQ|Transmission** menu.

3.1.1 Basic settings in TD-SCDMA BTS mode

In the default setting after preset the analyzer is in spectrum mode. The following default settings of code domain measurement are not activated until you select TD-SCDMA BTS mode with the TDS BS hotkey.

Table 1 Default settings of code domain measurement after preset

Parameters	Setting
Digital standard	TD-SCDMA (3GPP)
Sweep	CONTINUOUS
CDP mode	CODE CHAN AUTOSEARCH
Trigger setting	FREE RUN
Scrambling code	0
Max. number midamble shifts	16
Threshold for inactive channel	-40 dB
Channel	1.16
Slot number	0
Capture length	7 slots
Evaluation	Screen A: CODE PWR RELATIVE Screen B: RESULT SUMMARY

The following conventions apply to the presentation of settings on the analyzer:

[<Key>] Press a key on the front panel, e.g. [FREQ].

[<SOFTKEY>] Press a softkey, e.g. [MARKER -> PEAK].

[<nn unit>] Enter a value and terminate with the unit, e.g. [12 kHz].

Bei der Darstellung der Einstellungen am R&S SMIQ gelten folgende Konventionen:

[<Key>] Press a key on the front panel, e.g. [FREQ].

<MENU> Select a menu, parameter or setting, e.g. *DIGITAL STD*. The menu level is identified by indenting.

<nn unit> Enter a value and terminate with the unit, e.g. *12 kHz*.

To synchronize, you must activate channel 1.16 in slot 0.

3.2 Measurement 1: Measuring signal power

Measurement of the spectrum gives an overview of the TD-SCDMA signal and spurious emissions close to the carrier.

Test setup

- ▶ Connect the RF output of the R&S SMIQ to the RF input of the analyzer (coaxial cable with N connectors).
- ▶ Connect the external triggering of the analyzer (EXT TRIG GATE) to the R&S SMIQ trigger (TRIGOUT1 to PARDATA).

Settings on R&S SMIQ:

[PRESET]

[LEVEL: 0 dBm]

[FREQ: 2020.0 MHz]

ARB MOD

SET SMIQ ACCORDING TO WAVEFORM ...

SET SMIQ ACCORDING TO WAVEFORM ON

TRIGGER OUT MODE ON

(These settings are only needed once after presetting the generator and serve for automatically adopting the trigger setting from the waveform file generated by R&S WinIQSIM in ARB MOD. This is especially convenient when changing between different waveforms.)

SELECT WAVEFORM... Select name 'TDS_BS'

STATE: ON

Settings on analyzer:

[PRESET]

[FREQUENCY: 2020.0 MHz]

[TDS BS]

[AMPT: REF LEVEL]

[MEAS: POWER]

[ADAPT TO SIGNAL]

[AUTO LEVEL&TIME]

[START SLOT: 4]

[STOP SLOT: 6]

Measurement on analyzer:

The following is displayed:

- Spectrum of the TD-SCDMA signal over slots 4 through 6
- Channel power within a 1.6 MHz bandwidth

3.3 Measurement 2: Measuring spectrum emission mask

TD-SCDMA specifications require a measurement that monitors maintenance of a spectral mask within at least ± 4.0 MHz of the TD-SCDMA carrier. To judge power emissions, the signal power is measured with a 30 kHz filter up to 2.3 MHz and with a 1 MHz filter between 2.3 and 4 MHz. The resulting curve is compared to a limit line defined in TD-SCDMA specifications.

Test setup

- ▶ Connect the RF output of the R&S SMIQ to the RF input of the analyzer (coaxial cable with N connectors).
- ▶ Connect the external triggering of the analyzer (EXT TRIG GATE) to the R&S SMIQ trigger (TRIGOUT1 to PARADATA).

Settings on R&S SMIQ:

R&S SMIQ settings as for measurement 1

Settings on analyzer:

[PRESET]

[FREQUENCY: 2020.0 MHz]

[TDS BS]

[AMPT: REF LEVEL]

[MEAS: SEPCTRUM EM MASK]

[ADAPT TO SIGNAL]

[AUTO LEVEL&TIME]

[START SLOT: 4]

[STOP SLOT: 6]

Measurement on analyzer:

The following is displayed:

- Spectrum of the TD-SCDMA signal over slots 4 through 6
- The limit line defined in the standard
- Statement of limit line violation (passed/failed)

3.5 Measurement 3: Measuring relative code domain power and frequency error

What follows is a measurement of the code domain power. The basic parameters of CDP measurements, which allow analysis of the signal, are changed one after another from values adapted to the measurement signal to non-adapted values to demonstrate the resulting effects.

Test setup:

- ▶ Connect the RF output of the R&S SMIQ to the RF input of the analyzer.

Settings on R&S SMIQ:

R&S SMIQ settings as for measurement 1

Settings on analyzer:

[PRESET]

[FREQUENCY: 2020.0 MHz]

[TDS BS]

[AMPT: REF LEVEL]

[SELECT SLOT: 4]

Measurement on analyzer:

The following is displayed:

- Screen A: Code domain power of the signal in slot 4
- Screen B: Numeric results of CDP measurement including the frequency error

3.5.1 Setting: Synchronizing reference frequencies

Synchronizing the transmitter and receiver to the same reference frequency reduces the frequency error.

Test setup

- ▶ Connect the reference input (EXT REF IN / OUT) on the rear panel of the analyzer to the reference output (REF) on the rear of the R&S SMIQ (coaxial cable with BNC connectors).

Settings on R&S SMIQ:

- ▶ R&S SMIQ settings as for measurement 1

Settings on analyzer:

As for measurement 3, plus
[SETUP: REFERENCE EXT]

Measurement on analyzer:

Screen B: Frequency error: The indicated frequency error should be < 10 Hz.

The reference frequencies of the analyzer and device under test should be synchronized.

3.5.2 Setting: Response to deviating center frequency setting

The following shows the response of the DUT and analyzer to a deviating center frequency setting.

Settings on R&S SMIQ:

- ▶ Detune the center frequency of the signal generator in 0.5 kHz increments and observe the analyzer screen while doing so:

Measurement on analyzer:

- Up to a frequency error of about 4.5 kHz a CDP measurement is still possible on the analyzer. There is no apparent difference in the accuracy of CDP measurement up to this frequency error.
- Above 4.5 kHz frequency offset, the probability of incorrect synchronization increases. The "Sync Failed" message appears.
- Above a frequency error of about 5 kHz, a CDP measurement becomes impossible. The "Sync Failed" message appears.

Settings on R&S SMIQ:

- ▶ Reset the signal generator center frequency to 2020.0 MHz:
[FREQ: 2020.0 MHz]

The analyzer center frequency should not offset from the DUT frequency by more than 4.5 kHz.

3.5.3 Setting: Response to wrong scrambling code

You can only perform a valid CDP measurement if the scrambling code set on the analyzer matches that of the transmit signal.

Settings on R&S SMIQ

R&S SMIQ settings as for measurement 1

Settings on analyzer:

- ▶ Set the scrambling code to a wrong figure:

[SETTINGS: SCRAMBLING CODE 1]

Measurement on analyzer:

The "Sync Failed" message appears. In some cases a wrong scrambling code will lead to display of a valid signal but with the wrong channel occupancy!

Settings on analyzer:

Set the scrambling code to the correct figure:

[SETTINGS: SCRAMBLING CODE 0]

Measurement on analyzer:

The CDP display again shows the test mode.

The setting of the scrambling code on the analyzer must agree with that of the signal to be measured.

3.6 Measurement 4: Measuring composite EVM

Composite EVM is a measurement of the mean square error of the total signal required by TD-SCDMA specifications.

An ideal reference signal is generated from the demodulated data. The test signal and reference signal are compared; the square deviation produces the composite EVM.

Test setup

- ▶ Connect the RF output of the R&S SMIQ to the RF input of the analyzer (coaxial cable with N connectors).

Settings on R&S SMIQ:

R&S SMIQ settings as for measurement 1

Settings on analyzer:

[PRESET]

[FREQUENCY: 2020.0 MHz]

[TDS BS]
 [AMPT: REF LEVEL
 [RESULTS COMPOSITE EVM]
 [SELECT SLOT: 4]

Measurement on analyzer:

The following is displayed:

- Screen A: Code domain power of the signal in slot 4
- Screen B: Composite EVM (EVM for total signal)



EVM measurement serves no purpose in inactive slots. No figure is displayed

3.7 Measurement 5: Measuring peak code domain errors

An ideal reference signal is generated from the demodulated data for peak code domain error measurement. The test signal and reference signal are compared; the difference between the two signals is projected to the class of the spreading factor 16. The peak code domain error is obtained by summing over the symbols of each slot of the difference signal and searching for the maximum error code.

Test setup

- ▶ Connect the RF output of the R&S SMIQ to the RF input of the analyzer (coaxial cable with N connectors).

Settings on R&S SMIQ:

R&S SMIQ settings as for measurement 1

Settings on analyzer:

[PRESET]
 [FREQUENCY: 2020.0 MHz]
 [TDS BS]
 [AMPT: REF LEVEL
 [RESULTS PK CODE DOM ERROR]
 [SELECT SLOT: 4]

Measurement on analyzer:

The following is displayed:

- Screen A: Code domain power of the signal in slot 4

- Screen B: Peak code domain error (for spreading factor 16)



Peak code domain error measurement serves no purpose in inactive slots. No figure is displayed

3.8 Measurement 6: Measuring RHO factor

What follows is a measurement of the RHO factor.

Settings on R&S SMIQ:

- ▶ Connect the RF output of the R&S SMIQ to the RF input of the analyzer.

Settings on R&S SMIQ:

R&S SMIQ settings as for measurement 1

Settings on analyzer:

[PRESET]

[FREQUENCY: 2020.0 MHz]

[TDS BS]

[AMPT: REF LEVEL]

[SELECT SLOT: 4]

Measurement on analyzer:

The following is displayed:

- Screen A: Code domain power of the signal in slot 4
- Screen B: Numeric results of CDP measurement in slot 4 including the RHO factor

4 Setup for Base Station Tests

NOTICE

Any non-compliance with these precautions may cause damage to the instrument.

Before putting the unit into operation, make sure that:

- The housing covers are in place and their screws have been tightened.
- Vent holes are not obstructed.
- No signal voltage levels above permissible limits are applied to the inputs.

The outputs of the instrument are not overloaded or wrongly connected.

This chapter describes the default settings of the analyzer for operation as a TD-SCDMA base station tester. A requisite before starting is that the analyzer is correctly configured and powered, as described in Chapter 1 of the operating manual for the basic unit. Furthermore, the Application Firmware R&S FS-K76 must be enabled. Installation and enabling of the application firmware are described in Chapter 1 of this software manual.

4.1 Standard test setup

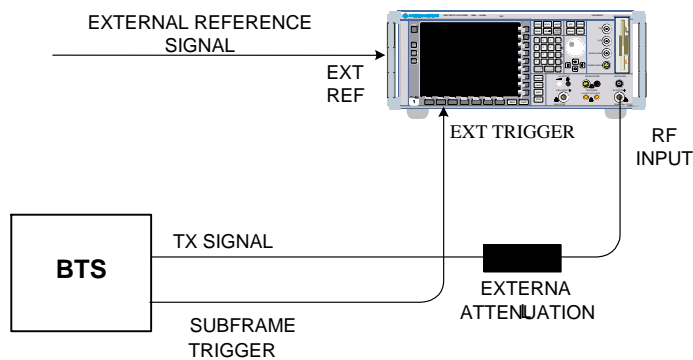

Figure 7 BTS test setup

- ▶ Connect the antenna output (or TX output) of the base station to the RF input of the analyzer through a power attenuator exhibiting suitable attenuation. The following values for external attenuation are recommended to ensure that the RF input of the analyzer is protected and the unit's sensitivity is not excessively degraded:

Max. power	Recommended external attenuation
≥ 55 to 60 dBm	35 to 40 dB
≥ 50 to 55 dBm	30 to 35 dB
≥ 45 to 50 dBm	25 to 30 dB
≥ 40 to 45 dBm	20 to 25 dB
≥ 35 to 40 dBm	15 to 20 dB
≥ 30 to 35 dBm	10 to 15 dB
≥ 25 to 30 dBm	5 to 10 dB
≥ 20 to 25 dBm	0 to 5 dB
< 20 dBm	0 dB

- ▶ For signal measurements at the output of two port networks, connect the reference frequency of the signal source to the rear reference input of the analyzer (*EXT REF IN / OUT*).
- ▶ To ensure adherence to the error limits required by TD-SCDMA specifications for frequency measurements on base stations, the analyzer must be operated on an external reference. A rubidium frequency standard is a possible reference source.
- ▶ If the base station has a trigger output, connect it to the rear trigger input of the analyzer (*EXT TRIG GATE*).

4.2 Default setting

- ▶ Enter the external attenuation. **[AMPT] [NEXT] [REF LVL OFFSET]**
- ▶ Enter the reference level. **[AMPT]**
- ▶ Enter the center frequency. **[FREQUENCY]**
- ▶ Set the trigger. **[TRIG]**
- ▶ If used, switch on the external reference. **[SETUP] [REF: EXT]**
- ▶ Select the standard and the required measurement. **[TDS BS] [RESULTS]**
- ▶ Set the scrambling code. **[SETTINGS] [SCRAMBLING CODE]**
- ▶ Set the maximum number of midambles. **[SETTINGS] [MA SHIFTS CELL]**

5 Menu Overview

The Application Firmware R&S FS-K76 (TD-SCDMA base station tests) expands the analyzer by RF and code domain power measurements for the TD-SCDMA forward link mobile radio standard

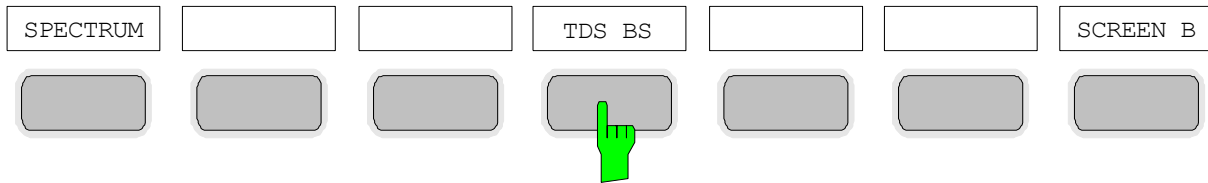

Figure 8 Hotkey bar with enabled Application Firmware R&S FS-K76

After you call up the application firmware with the *TDS BS* hotkey, a new hotkey bar appears at the bottom edge of the screen and the code domain analyzer is selected and started.

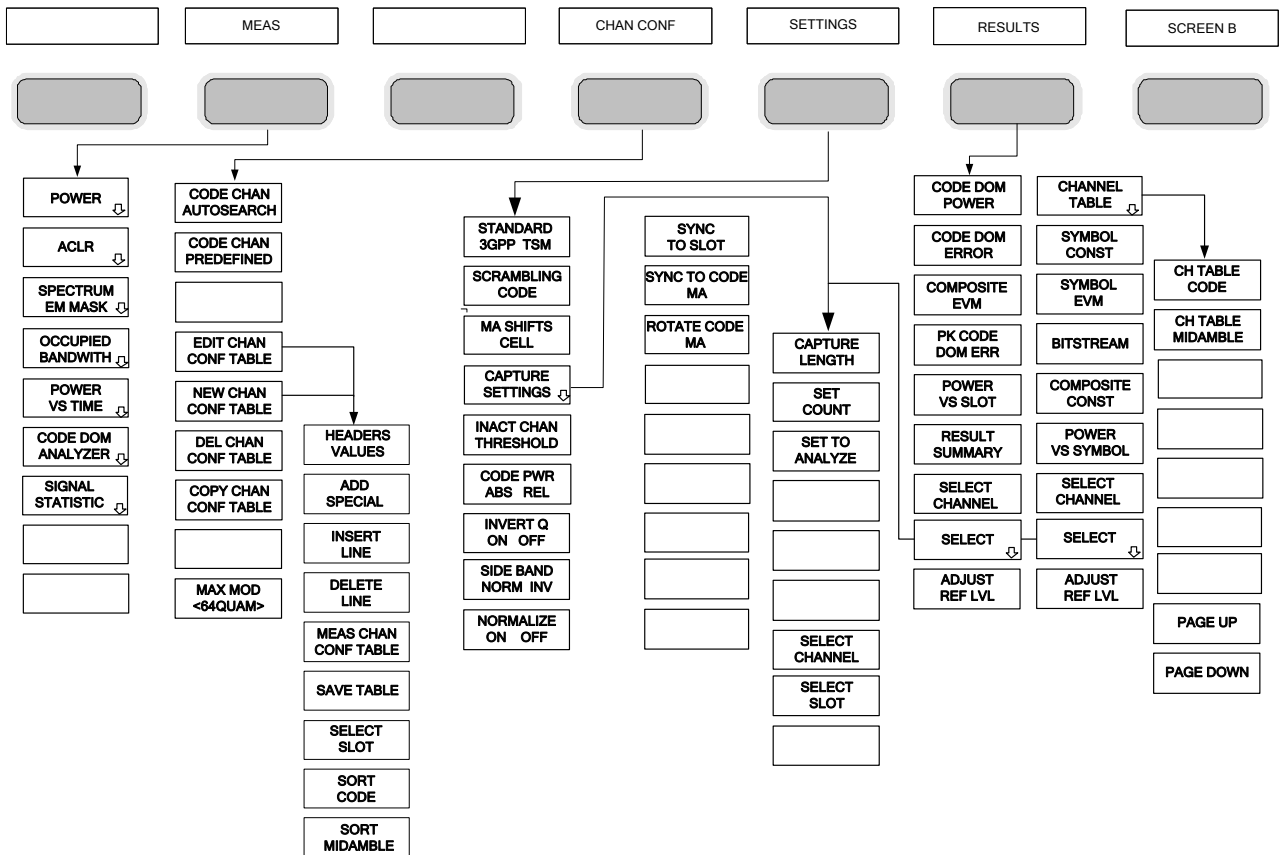

Figure 9 Overview of menus in Application Firmware R&S FS-K76

The code domain analyzer can produce different kinds of results. These can be selected by the *RESULTS* hotkey. The *SETTINGS* hotkey is used to configure the application firmware. In this menu you can set the scrambling code of the base station for example. The *CHAN CONF* hotkey sets the channel search mode for the code domain analyzer. Own channel tables can also be defined.

The *MEAS* hotkey is identical to the *MEAS* key (right on the front panel) and is used to select the different RF measurements or the code domain analyzer.

Selecting the *CHAN CONF* or *RESULTS* hotkey automatically switches to the code domain analyzer.

Pressing the *EXIT TDS* hotkey exits from R&S FS-K76. The hotkey bar of the basic unit appears again and the analyzer goes into the default *SPECTRUM* mode.

Change from *SPECTRUM* mode to application firmware:

The following user-specific settings are not modified, so the matching to the device under test is preserved:

- Reference Level + Ref Level Offset
- Center Frequency + Frequency Offset
- Input Attenuation + Mixer Level

The following user-specific settings are adopted as follows:

- External trigger sources are preserved, while all other trigger sources result in *FREE RUN* mode.
- Additional trigger settings are preserved.

Change from application firmware to *SPECTRUM* mode:

The following user-specific settings are not modified, so the matching to the device under test is preserved:

- Reference Level + Ref Level Offset
- Center Frequency + Frequency Offset
- Input Attenuation + Mixer Level

The following user-specific settings are adopted as follows:

- The trigger source is switched to *FREE RUN* and an analyzer frequency sweep is set with the span equal to double the center frequency, or the maximum possible span, so that in any case the center frequency remains unchanged.

The measurements available in R&S FS-K76 can be selected by the *MEAS* hotkey or the *MEAS* key:

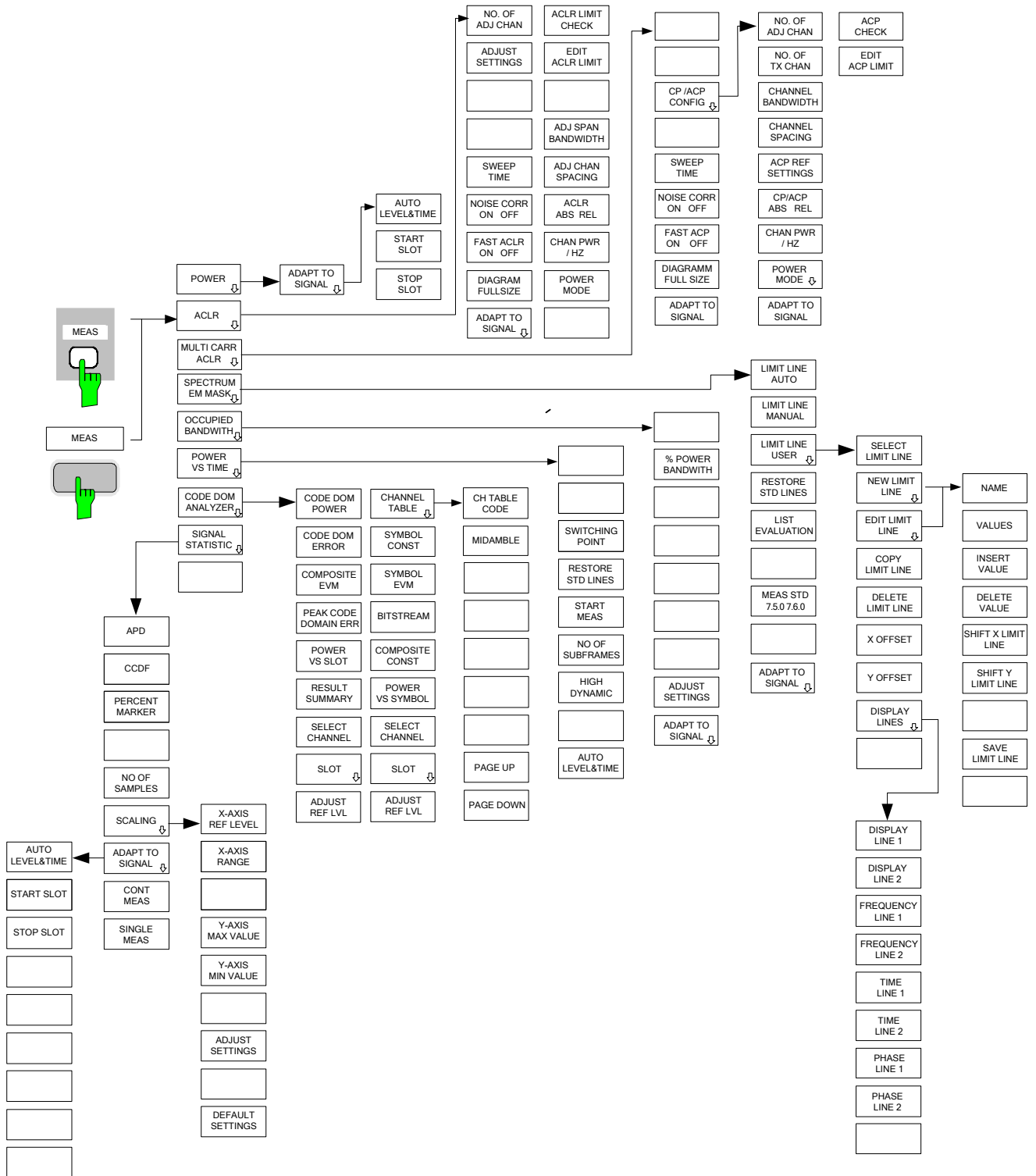

Figure 10 Overview of menus

6 Configuration of TD-SCDMA Measurements

The major measurements of the TD-SCDMA specifications for base stations can be selected by the *MEAS* hotkey and the *MEAS* key. They are explained below with reference to the softkey functions.

The *CODE DOM ANALYZER* softkey activates the code domain analyzer and takes you to the submenus for selecting the results. Changing the occupancy of the hotkey bar when entering the application ensures that the major parameters of the code domain analyzer can be directly accessed on the hotkey bar.

The *POWER*, *ACLR*, *SPECTRUM EM MASK*, *OCCUPIED BANDWIDTH* and *POWER VS TIME* softkeys activate base station measurements with predefined settings that are performed in *SPECTRUM* mode of the basic unit. The measurements are performed with the parameters of the TD-SCDMA specifications. Subsequent alteration of the settings is possible.

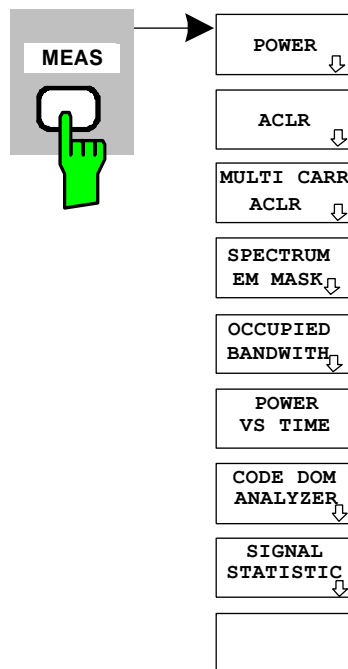

The *MEAS* hotkey or the *MEAS* key opens a submenu for selecting measurements:

- *POWER* activates channel power measurement with defined defaults in *SPECTRUM* mode.
- *ACLR* activates adjacent channel power measurement with defined defaults in *SPECTRUM* mode.
- *MULT CARR ACLR* activates measurement of the multi carrier adjacent channel power
- *SPECTRUM EM MASK* compares the signal power in different carrier offset ranges with the maximum values of the TD-SCDMA specifications.
- *OCCUPIED BANDWIDTH* activates measurement of the bandwidth occupied by the signal.

- *POWER VS TIME* activates measurement of the signal power versus time with the template of TD-SCDMA specifications.
- *CODE DOM ANALYZER* activates the code domain analyzer and opens another menu for choosing the results. All other menus of the analyzer are matched to the functions of the code domain analyzer mode. The code domain analyzer is described in a separate chapter starting on page 57.
- *SIGNAL STATISTIC* evaluates the signal with regard to its statistical characteristics (distribution function of the signal amplitudes).

6.1 Measurement of channel power

MEAS key or MEAS hotkey

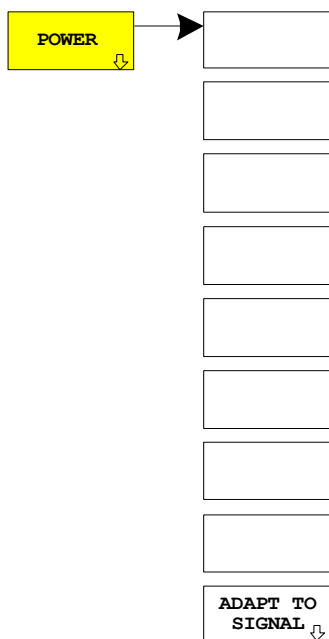

The *POWER* softkey activates measurement of channel power of the TD-SCDMA signal.

The analyzer measures the power of the RF signal over a bandwidth of 1.6 MHz in selected slots. The power is calculated by summing the values at the trace points. The bandwidth and the associated channel power are displayed below the measurement screen.

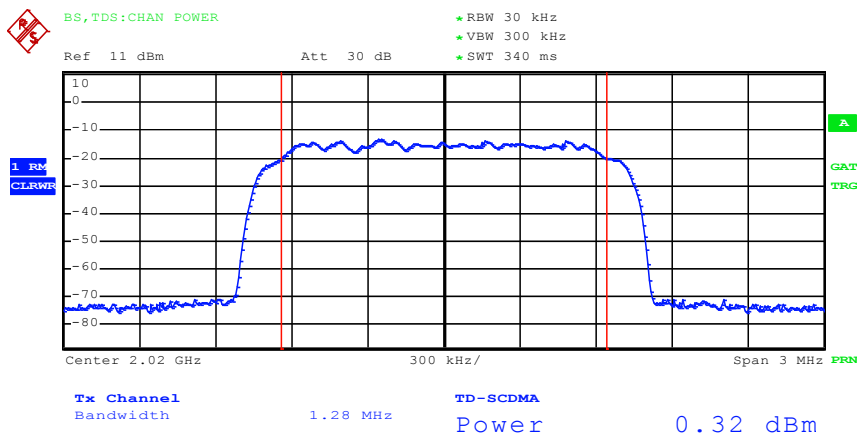

Figure 11 Power measurement over 1.6 MHz bandwidth

The softkey activates *SPECTRUM* mode with defined settings:

The following user-specific settings are not modified, so the matching to the device under test is preserved:

- Reference Level + Rev Level Offset
- Center Frequency + Frequency Offset
- Input Attenuation + Mixer Level

ADJACENT CHAN POWER	ON
FREQUENCY SPAN	3 MHz
TRIGGER	EXTERN

Proceeding from this setting, the analyzer can be operated with all the functionality it offers in *SPECTRUM* mode, i.e. all parameters can be matched to a specific measurement.

To restore adapted measurement parameters, the following parameters are saved on exiting and are set again on re-entering this measurement:

- Level parameters
- RBW, VBW
- Sweep time

Remote: CONF:CDP:MEAS POW

Result poll: CALC:MARK:FUNC:POW:RES? CPOW

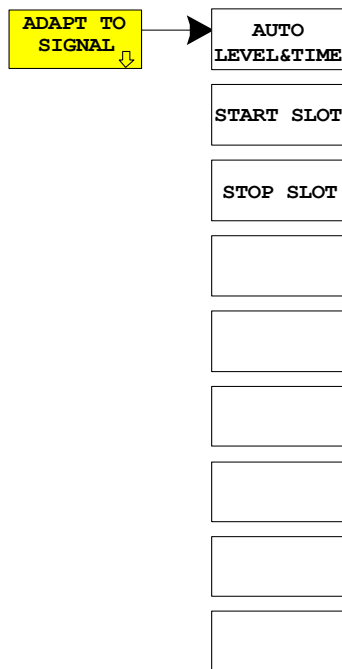

The *ADAPT TO SIGNAL* softkey opens a submenu for matching the reference level of the analyzer and configuration of the gated sweep mode.

The reference level of the analyzer is matched to the measured channel power. This ensures that the RF attenuation and reference level settings are optimally matched to the signal level without the analyzer being overloaded or the dynamic response limited by too low a signal/noise ratio.

The measurement bandwidth for channel power measurements is considerably less than the signal bandwidth, so the signal path may be overloaded although the trace is still well below the reference level.

Power measurements are only possible in gated sweep mode because the TD-SCDMA signal is slot-based. So the trigger/subframe relationship must be created and the slots set that are to be analyzed. Analysis is possible over contiguous slots 1 through 7. Slot 7 corresponds to slot 0 of the following subframe. In TD-SCDMA specifications, analysis is over slots 4, 5 and 6. An external trigger signal must be applied.

The guard period of the stop slot is excluded from the measurement. The sweep time is adapted to the gate length, so that for every sweep point all selected slots are taken into account.

AUTO LEVEL & TIME

The *AUTO LEVEL & TIME* softkey starts the autorange routine for the reference level. This also creates the relationship between trigger and subframe start.

Remote: SENS:POW:ACH:AUTO:LTIM

START SLOT

The *START SLOT* softkey allows entry of the start slot for gated sweep mode. The gated mode is on between START SLOT and STOP SLOT. For the remaining slots of a subframe the gated mode is off.

Remote: SENS:POW:ACH:SLOT:START 1...7

STOP SLOT

The *STOP SLOT* softkey allows entry of the stop slot for gated sweep mode. The gated mode is on between START SLOT and STOP SLOT. For the remaining slots of a subframe the gated mode is off.

Remote: SENS:POW:ACH:SLOT:STOP 1...7

6.2 Measurement of adjacent channel power - ACLR

MEAS key or MEAS hotkey

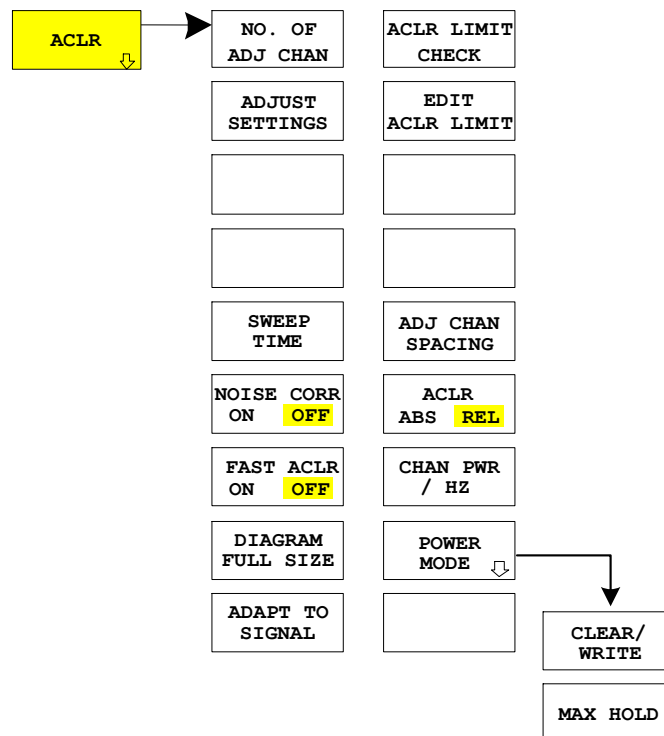

The *ACLR* (adjacent channel leakage power ratio) softkey activates measurement of adjacent channel power. Settings and limits are taken from the ACLR measurement defined in TD-SCDMA specifications.

The analyzer measures the power of the useful channel and of the adjacent left and right channels in selected slots. In the default setting, only two adjacent channels are considered. Measurement results are displayed below the measurement screen.

The ACLR limit check can be enabled or disabled by the *ACLR LIMIT CHECK* softkey.

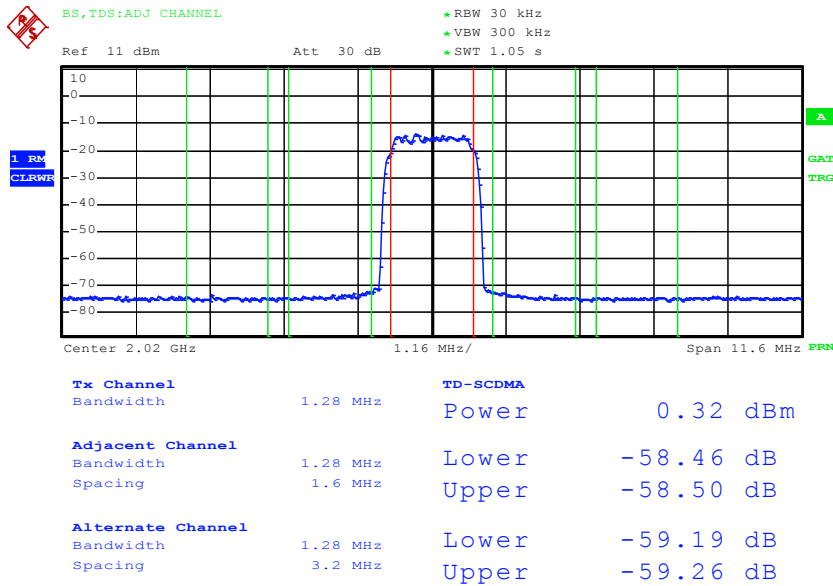

Figure 12 Measuring adjacent channel power

```
Remote: CONF:CDP:MEAS ACLR
Result poll: CALC:MARK:FUNC:POW:RES? ACP
```

The softkey activates *SPECTRUM* mode with defined settings:

The following user-specific settings are not modified, so the matching to the device under test is preserved:	
Reference Level + Ref Level Offset	
Center Frequency + Frequency Offset	
Input Attenuation + Mixer Level	
ADJACENT CHAN POWER	ON
ACP STANDARD	TD-SCDMA
NO OF ADJ CHANNELS	2
TRIGGER	EXTERN
EXT GATE	ON

Table 2: Default ACLR settings

Adjacent channel type	Spacing	RBW	Abs. Limit
Adjacent	±1.6 MHz	30 kHz	-15.2 dBm
Alternate	±3.2 MHz	30 kHz	-15.2 dBm

Proceeding from this setting, the analyzer can be operated in all the functions it features in *SPECTRUM* mode, i.e. all measurement parameters can be matched to the specific measurement.

To restore adapted measurement parameters, the following parameters are saved on exiting and are set again on re-entering this measurement:

Level parameters
 RBW, VBW
 Sweep time
 SPAN
 NO OF ADJ. CHANNELS
 FAST ACLR MODUS

```
Remote: CONF:CDP:MEAS ACLR
Result poll: CALC:MARK:FUNC:POW:RES? ACP
```

NO. OF ADJ CHAN

The *NO. OF ADJ CHAN* softkey activates entry of the number $\pm n$ of adjacent channels that are taken into account for the adjacent channel power measurement.

A number between 0 and 12 can be entered.

The following measurements are performed depending on the number of channels.

- 0 Only the channel power is measured.
- 1 The channel power and the power of the upper and lower adjacent channel are measured.
- 2 The channel power, the power of the upper and lower adjacent channel and of the next upper and lower channel (alternate channel 1) are measured.
- 3 The channel power, the power of the upper and lower adjacent channel and of the next two upper and two lower channels (alternate channel 1 and alternate channel 2) are measured.

With higher numbers the procedure is expanded accordingly.

```
Remote: SENS:POW:ACH:ACP 2
```

ADJUST SETTING

All analyzer settings relevant for power measurement within a specific frequency band (channel bandwidth) are optimally set as a function of channel configuration (channel bandwidth, channel spacing):

- Frequency span:
 The frequency span must at least cover all channels to be considered.
 When channel power is measured, the span is set to double the channel bandwidth.
 The setting of the span for adjacent channel power measurement depends on the channel spacing and channel bandwidth of the adjacent channel ADJ, ALT1 or ALT2 furthest from the transmission channel.
- Resolution bandwidth $RBW \leq 1/40$ of channel bandwidth
- Video bandwidth $VBW \geq 3 \times RBW$.
- Detector RMS detector

The trace math and trace averaging functions are switched off.

The reference level is not influenced by *ADJUST SETTINGS*. It can be separately adjusted with *AUTO LEVEL&TIME*.

Adjustment is performed once; if necessary, the unit settings can be modified afterwards..

Remote: `SENS:POW:ACH:PRES ACP|CPOW|OBW`

For manual setting of the measurement parameters differing from the settings made with *ADJUST SETTINGS*, the following must be taken into account for the different parameters:

Frequency span	<p>The frequency span must at least cover all channels to be measured.</p> <p>This is the channel bandwidth when channel power is measured</p> <p>If the frequency span is large compared with the analyzed frequency section (or frequency sections), only a few points on the trace are available for the measurement.</p>
Resolution bandwidth (RBW)	<p>To ensure an acceptable measurement speed and also the necessary selectivity (to reject spectral components outside the channel you want to measure, especially the adjacent channels), the resolution bandwidth must be neither too small nor too large. As a rule of thumb, the resolution bandwidth should be set to between 1 and 4% of the channel bandwidth. A larger resolution bandwidth can be set if the spectrum within and around the channel you want to measure has a flat characteristic.</p>
Video bandwidth (VBW)	<p>For a correct power measurement, the video signal must not be limited in terms of bandwidth. A restricted band of the logarithmic video signal would result in averaging and thus in too small an indication of the power (-2.51 dB for very small video bandwidths). So the video bandwidth should be at least three times the resolution bandwidth. The <i>ADJUST SETTINGS</i> softkey sets the video bandwidth (VBW) as a function of the channel bandwidth as follows:</p> $VBW \geq 3 \times RBW$
Detector	<p>The <i>ADJUST SETTINGS</i> softkey selects the RMS detector.</p> <p>The RMS detector is selected because it always indicates the power correctly irrespective of the characteristics of the signal you want to measure. In principle, even the sample detector would be possible. However, this would lead to more unstable results due to the limited number of trace pixels for calculating the power in the channel. Averaging frequently performed to stabilize measurement results, leads to the level indication being too low and should therefore be avoided. The reduction in the displayed power</p>

depends on the number of averages and the signal characteristics in the channel you want to measure.

SWEEP TIME

The *SWEEP TIME* softkey activates entry of the sweep time. When the RMS detector is used, a longer sweep time yields more stable results.

This setting is identical to the *SWEEP TIME MANUAL* setting in the *BW* menu

```
Remote:  SWE:TIME <value>
```

NOISE CORR ON / OFF

If the *NOISE CORR ON / OFF* softkey, is activated, the results are corrected by the instrument's own inherent noise, which increases the dynamic range.

When the function is switched on, a reference measurement of the instrument's inherent noise is first made. The measured noise power is then subtracted from the power in the channel examined. The inherent noise of the instrument depends on the selected center frequency, resolution bandwidth and level setting. So correction is disabled whenever one of these parameters is changed, and an appropriate message appears on the screen. To reactivate correction of the inherent noise with the changed setting, press the softkey once more. A new reference measurement is then made.

The function can be switched on with trigger *FREE RUN* or *EXTERN*. Then it is possible to change the trigger to an arbitrary mode.

```
Remote:  SENS:POW:NCOR ON
```

FAST ACLR ON / OFF

The *FAST ACLR ON / OFF* softkey toggles between measurement by the *IBW* method (*FAST ACLR OFF*) and measurement in the time domain (*FAST ACLR ON*).

For *FAST ACLR ON* the power is measured in the various channels in the time domain. The analyzer sets its center frequency in succession to the different channel center frequencies and measures the power with the set measuring time (i.e. sweep time/number of measured channels). The RBW filters suitable for the selected standard and frequency offset are used automatically.

The RMS detector is used for correct power measurement. Software correction factors are not required in this case.

Measured values are output in the form of a table, the power of the useful channel being specified in dBm and the power of the adjacent channels in dB (*ACLR ABS*) or dB (*ACLR REL*).

The selected sweep time (= measurement time) depends on the desired reproducibility of measurement results. The longer the selected sweep time, the better the reproducibility of results, because power is measured over a longer period of time.

As a rule of thumb it can be assumed that approx. 500 uncorrelated values are required for reproducibility of 0.5 dB, i.e. 99% of measurements are within 0.5 dB of the true measured value (applies to white noise). Measured values are considered uncorrelated if their time spacing corresponds to the reciprocal of the measurement bandwidth (1/BW).

```
Remote: SENS:POW:HSP ON
```

DIAGRAM FULL SIZE

The *DIAGRAM FULL SIZE* softkey switches the diagram to full screen size

```
Remote: DISP:WIND1:SIZE LARG
        DISP:WIND1:SIZE SMAL
```

The *ADAPT TO SIGNAL* softkey opens a submenu for matching the reference level of the analyzer and configuration of gated sweep mode.

The *AUTO LEVEL & TIME* softkey starts the autorange routine for the reference level. This also creates the relationship between trigger and subframe start.

The *START SLOT* softkey allows entry of the start slot for gated sweep mode. The gated mode is on between START SLOT and STOP SLOT. For the remaining slots of a subframe the gated mode is off.

The *STOP SLOT* softkey allows entry of the stop slot for gated sweep mode. The gated mode is on between START SLOT and STOP SLOT. For the remaining slots of a subframe the gated mode is off.

```
Remote: SENS:POW:ACH:AUTO:LTIM
        SENS:POW:ACH:SLOT:START 1...7
        SENS:POW:ACH:SLOT:STOP 1...7
```

ACLR LIMIT CHECK

The *ACLR LIMIT CHECK* softkey switches the limit check for the ACLR measurement on or off.

```
Remote: CALC:LIM:ACP ON
        CALC:LIM:ACP:ACH:RES?
        CALC:LIM:ACP:ALT1...11:RES?
```

EDIT ACLR LIMIT

The default setting of the limits when starting adjacent channel power measurement is defined as in the table on page 32. A table can be opened in ACLR measurement by the *EDIT ACLR LIMIT* softkey in which limits for ACLR measurement can be modified.

ACP LIMITS				
CHAN	RELATIVE LIMIT CHECK		ABSOLUTE LIMIT CHECK	
	VALUE	ON	VALUE	ON
ADJ	0 dBc		-15.2 dBm	√
ALT1	0 dBc		-15.2 dBm	√
ALT2	0 dBc		0 dBm	

The following rules apply for limit values:

- A limit value can be defined for each of the adjacent channels. The limit value applies to both the upper and lower adjacent channel.
- A relative limit and/or an absolute limit can be defined. The check can be activated separately for the two limit values.
- Compliance with active limit values is checked irrespective of whether absolute or relative limits are specified or whether the measurement itself is performed with absolute levels or a relative level ratio. If the two checks are active and the higher of the two levels is exceeded, the respective value will be marked.



Measured values violating the limit are printed red and preceded by an asterisk

```
Remote:  CALC:LIM:ACP ON
          CALC:LIM:ACP:ACH 0dB,0dB
          CALC:LIM:ACP:ACH:STAT ON
          CALC:LIM:ACP:ACH:ABS -10dBm,-10dBm
          CALC:LIM:ACP:ACH:ABS:STAT ON
          CALC:LIM:ACP:ALT1 0dB,0dB
          CALC:LIM:ACP:ALT1:STAT ON
          CALC:LIM:ACP:ALT1:ABS -10dBm,-10dBm
          CALC:LIM:ACP:ALT1:ABS:STAT ON
          CALC:LIM:ACP:ALT2..11 0dB,0dB
          CALC:LIM:ACP:ALT2..11:STAT ON
          CALC:LIM:ACP:ALT2..11:ABS -10dBm,-10dBm
          CALC:LIM:ACP:ALT2..11:ABS:STAT ON
```

ADJ CHAN SPACING

The *ADJ CHAN SPACING* softkey opens a table for defining the channel spacings.

CHANNEL SPACING	
CHAN	SPACING
ADJ	1.6 MHz
ALT1	3.2 MHz
ALT2	4.8 MHz

Adjacent channels frequently have identical spacings, so entering the adjacent channel spacing ADJ sets channel ALT1 to twice and channel ALT2 to three times the channel spacing of the adjacent channel. This means that only one value has to be entered when channel spacings are identical. The same applies to the ALT2 channel when entering the spacing of the ALT1 channel.



Channel spacings can be set independently of each other by overwriting the table from top to bottom.

```
Remote:  SENS:POW:ACH:SPAC:ACH 1.6MHz
          SENS:POW:ACH:SPAC:ALT1 3.2MHz
          SENS:POW:ACH:SPAC:ALT2..11 4.8MHz
```

ACLR ABS / REL

The *ACLR ABS / REL* softkey toggles between absolute and relative measurement of the channel power.

ACLR ABS The absolute value of the power in the transmission channel and the adjacent channels is displayed in the units of the Y axis, e.g. dBm, dB μ V.

ACLR REL In adjacent channel power measurement (*NO. OF ADJ CHAN* > 0), the level of the adjacent channels is displayed relative to the level of the transmission channel in dBc.

With linear scaling of the Y axis, the relative power (CP/CP_{ref}) of the new channel to the reference channel is displayed. With dB scaling, the logarithmic ratio $10 \cdot \lg(CP/CP_{ref})$ is displayed. This means that the relative channel power measurement can also be used for general adjacent channel power measurements. Each channel is measured separately in this latter instance.

Remote: SENS:POW:ACH:MODE ABS

CHAN PWR / HZ

The *CHAN PWR / HZ* softkey toggles between measurement of the total power in the channel and power measurement referred to 1 Hz bandwidth.

The conversion factor is $10 \cdot \lg \frac{1}{\text{Channel} \cdot \text{Bandwidth}}$.

Remote: CALC:MARK:FUNC:POW:RES:PHZ ON|OFF

POWER MODE

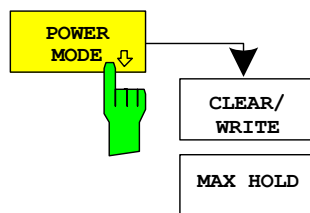

The *POWERMODE* submenu allows to change between the normal (*CLEAR/WRITE*) and the max hold power mode. In the *CLEAR/WRITE* the channel power and the adjacent channel powers are calculated directly from the current trace. In *MAX HOLD* mode the power values are still derived from the current trace, but they are compared with a maximum algorithm to the previous power value. The greater value is remained.

Remote: CALC:MARK:FUNC:POW:MODE WRIT|MAXH

6.3 Menu MEAS - MULT CARR ACLR

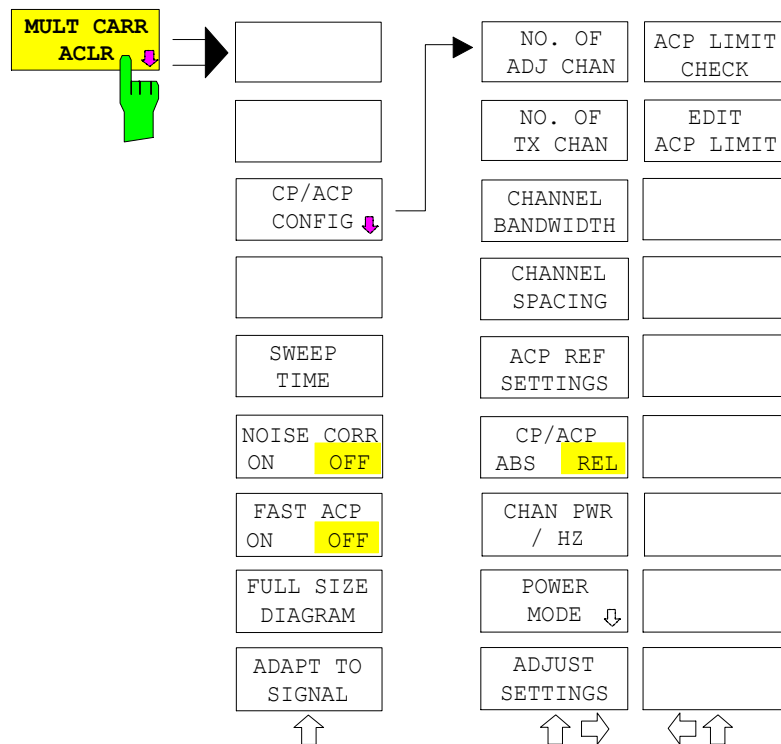

The *MULT CARR ACLR* (Multi Carrier Adjacent Channel Leakage Power Ratio) softkey enables measurement of the multi carrier adjacent channel power.

The analyzer measures the power of the 4 useful channels and of the adjacent channels on the left and right sides. In the default setting, only two adjacent channels are taken into account. Measurement results are displayed beneath the measurement screen.

The ACLR limit check can be enabled or disabled by means of the *ACLR LIMIT CHECK* softkey.

Remote: CONF:CDP:MEAS MCAC

Result poll: CALC:MARK:FUNC:POW:RES? MCAC

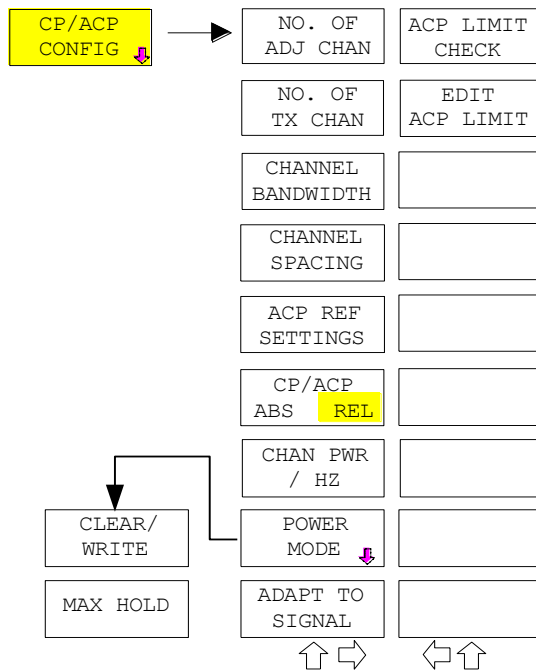

The *CP/ACP CONFIG* softkey opens a submenu for configuration of the multi carrier adjacent channel power measurement.

The channel configuration includes the number of channels to be measured, the channel bandwidths (*CHANNEL BANDWIDTH*), and the channel spacings (*CHANNEL SPACING*).

Limit values can additionally be specified for the adjacent-channel power (*ACP LIMIT CHECK* and *EDIT ACP LIMITS*) which are checked for compliance during the measurement.

NO. OF ADJ CHAN

This softkey behaves as in the adjacent channel power measurement - ACLR. Refer there.

NO OF TX CHAN

The *NO. OF TX CHAN* softkey enables the entry of the number of carrier signals to be considered.

Numbers from 1 to 12 can be entered.

Remote: SENS:POW:ACH:TXCH:COUN 4

CHANNEL BANDWIDTH

The *CHANNEL BANDWIDTH* softkey opens a table for defining the channel bandwidths for the transmission channels and the adjacent channels.

```
Remote:  SENS:POW:ACH:BWID:CHAN 1.28MHz
         SENS:POW:ACH:BWID:ACH  1.28MHz
         SENS:POW:ACH:BWID:ALT1..11 1.28MHz
```

CHANNEL SPACING

The *CHANNEL SPACING* softkey opens a table for defining the channel spacings of the TX channel and the adjacent channels.



The channel spacing can be set separately by overwriting the table from top to bottom.

```
Remote:  SENS:POW:ACH:SPAC:CHAN 1.6MHz
         SENS:POW:ACH:SPAC:ACH  1.6MHz
         SENS:POW:ACH:SPAC:ALT1 1.6MHz
         SENS:POW:ACH:SPAC:ALT2 2.3MHz
```

ACP REF SETTINGS

The *ACP REF SETTINGS* softkey opens a table for selecting the transmission channel to which the adjacent-channel relative power values should be referenced..

ACP REFERENCE CHANNEL
<input checked="" type="checkbox"/> TX CHANNEL 1
<input type="checkbox"/> TX CHANNEL 2
<input type="checkbox"/> TX CHANNEL 3
<input type="checkbox"/> TX CHANNEL 4
<input type="checkbox"/> TX CHANNEL 5
<input type="checkbox"/> TX CHANNEL 6
<input type="checkbox"/> TX CHANNEL 7
<input type="checkbox"/> TX CHANNEL 8
<input type="checkbox"/> TX CHANNEL 9
<input type="checkbox"/> TX CHANNEL 10
<input type="checkbox"/> TX CHANNEL 11
<input type="checkbox"/> TX CHANNEL 12
MIN POWER TX CHANNEL
MAX POWER TX CHANNEL
LOWEST & HIGHEST CHANNEL

TX CHANNEL 1 - 12	Selection of one of channels 1 to 12.
MIN POWER TX CHANNEL	The transmission channel with the lowest power is used as a reference channel.
MAX POWER TX CHANNEL	The transmission channel with the highest power is used as a reference channel.
LOWEST & HIGHEST CHANNEL	The outer left-hand transmission channel is the reference channel for the lower adjacent channels, the outer right-hand transmission channel that for the upper adjacent channels.

```
Remote:  SENS:POW:ACH:REF:TXCH:MAN1
         SENS:POW:ACH:REF:TXCH:AUTO MIN
         SENS:POW:ACH:REF:TXCH:AUTO MAX
         SENS:POW:ACH:REF:TXCH:AUTO LHIG
```

CP/ACP ABS/REL

The *CP/ACP ABS/REL* softkey (channel power absolute/relative) switches between absolute and relative power measurement in the adjacent channels.

Remote: SENS:POW:ACH:MODE ABS

CHAN POW / HZ

This softkey behaves as in the adjacent channel power measurement - ACLR. Refer there.

ADJUST SETTINGS

The *ADJUST SETTINGS* softkey automatically optimizes the instrument settings for the selected power measurement (see below).

All instrument settings relevant for a power measurement within a specific frequency range (channel bandwidth) are optimized for the selected channel configuration (channel bandwidth, channel spacing).

Remote: SENS:POW:ACH:PRES MCAC

ACLR LIMIT CHECK

This softkey behaves as the *ACLR LIMIT CHECK* softkey in the adjacent channel power measurement - ACLR. Refer there.

EDIT ACLR LIMIT

This softkey behaves as in the *EDIT ACLR LIMIT* softkey in the adjacent channel power measurement - ACLR. Refer there.

SWEEP TIME MANUAL

The function of the softkey is identical to the softkey *SWEEP TIME MANUAL* in the menu *BW*.

Remote: SENS:SWE:TIM <value>

NOISE CORR ON/OFF

This softkey behaves as in the adjacent channel power measurement - ACLR. Refer there.

FAST ACP ON/OFF

This softkey behaves as in the adjacent channel power measurement - ACLR. Refer there.

FULL SIZE DIAGRAM

This softkey behaves as in the adjacent channel power measurement - ACLR. Refer there.

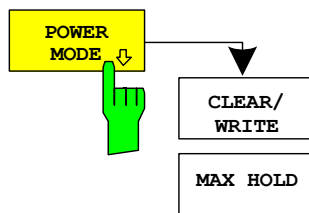

The *POWER MODE* sub menu allows to change between the normal (*CLEAR/WRITE*) and the max hold power mode. In the *CLEAR/WRITE* mode the channel power and the adjacent channel powers are calculated directly from the current trace. In *MAX HOLD* mode the power values are still derived from the current trace, but they are compared with a maximum algorithm to the previous power value. The greater value is remained.

Remote: CALC:MARK:FUNC:POW:MODE WRIT|MAXH

ADAPT TO SIGNAL

This softkey behaves as in the adjacent channel power measurement - ACLR. Refer there.

6.4 Checking signal power - SPECTRUM EM MASK

The *SPECTRUM EM MASK* (spectrum emission mask) softkey starts determination of the power of selected slots of the TD-SCDMA signal at defined offsets from the carrier and compares the power with the spectrum emission mask of TD-SCDMA specifications in the near-carrier range from -4 MHz to 4 MHz.

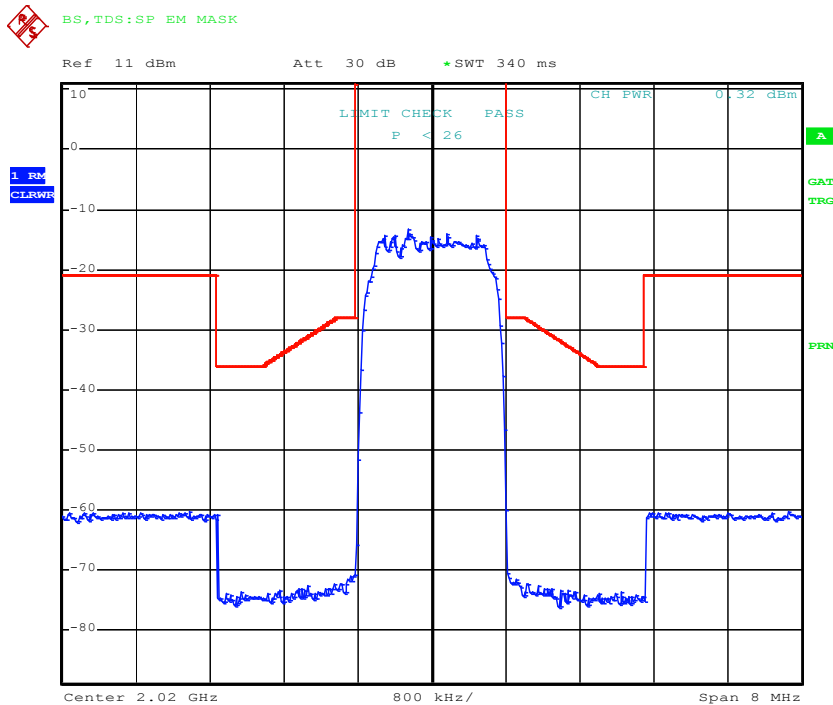
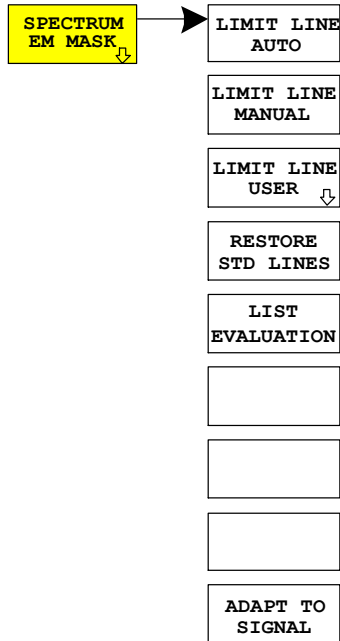

Figure 13 Measurement of spectrum emission mask (3GPP)

The softkey activates spectrum mode with defined settings

The following user-specific settings are not modified, so the matching to the device under test is preserved:	
Reference Level + Rev Level Offset Center Frequency + Frequency Offset Input Attenuation + Mixer Level	
ADJACENT CHAN POWER	ON
ACP STANDARD	TD-SCDMA
NO. OF ADJ. CHANNELS	0
FREQUENCY SPAN	8 MHz
DETECTOR	RMS
TRIGGER	EXTERN

Proceeding from these settings, the analyzer can be operated in many functions featured in *SPECTRUM* mode. Changing of the RBW and VBW is limited because they are set by the definition of the limits.

To restore adapted measurement parameters, the following parameters are saved on exiting and are set again on re-entering this measurement:

Level parameters
Sweep time
SPAN

```
Remote: CONF:CDP:MEAS ESP
```

```
Result polls: CALC:LIMit:FAIL?  
              CALC1:MARK1:FUNC:POW:RES? CPOW
```

```
Query of results of worst fail:  
CALC:LIM:ESP:CHECK:X?  
CALC:LIM:ESP:CHECK:Y?
```

LIMIT LINE AUTO

The *LIMIT LINE AUTO* softkey automatically selects the limit line after the power in the useful channel has been determined. If the measurement is performed in a *CONTINUOUS SWEEP* and the channel power varies from sweep to sweep, this can result in continuous replotting of the limit line.

The softkey is activated when you enter spectrum emission mask measurement in 3GPP standard.

```
Remote: CALC:LIM:ESP:MODE AUTO
```



If the standard TSM is selected (see softkey STANDARD in the SETTINGS menu) this softkey is not available. The limit lines have to be selected manual.

LIMIT LINE MANUAL

The *LIMIT LINE MANUAL* softkey enables you to select the limit line manually. If you press this softkey, the channel power measurement is not used to select the limit line but only to determine its relative components. The power at the different frequency offsets is compared with the limit line you have specified.

The softkey opens a table with all predefined limit lines on the unit:

Standard: 3GPP	Standard: TSM
limit line name	limit line name
P >= 34 dBm	P >= 43 dBm
26 dBm <= P < 34 dBm	39 <= P < 43 dBm
P < 26 dBm	31 <= P < 39 dBm
	P < 31 dBm

The name of the limit line specifies the expected power range for which the limit line was defined.

6.4.1 3GPP Norm: Spectrum Emission Mask

Table 3 Maximum output power P < 26 dBm

Offset frequency	Limit	Type/name TDSBCA.LIM	RBW
0.815 MHz - 1.015 MHz	-28 dBm	Absolute	30 kHz
1.015 MHz - 1.815 MHz	$-28dBm - 10 \cdot \left(\frac{f - f_c}{MHz} - 1,015 \right) dB$	Absolute	30 kHz
1.815 MHz - 2.3 MHz	-36 dBm	Absolute	30 kHz
2.3 MHz - Max	-21 dBm	Absolute	1 MHz

Table 4 Maximum output power 26 dBm <= P < 34 dBm

Offset frequency	Limit	Type/name TDSBCA.LIM	RBW
0.815 MHz - 1.015 MHz	P-54 dB	Relative	30 kHz
1.015 MHz - 1.815 MHz	$P - 54dB - 10 \cdot \left(\frac{f - f_c}{MHz} - 1,015 \right) dB$	Relative	30 kHz
1.815 MHz - 2.3 MHz	P-62 dB	Relative	30 kHz
2.3 MHz - Max	P - 47 dB	Relative	1 MHz

Table 5 Maximum output power 26 dBm <= P < 34 dBm

Offset frequency	Limit	Type/name TDSBCA.LIM	RBW
0.815 MHz - 1.015 MHz	-20 dBm	Absolute	30 kHz
1.015 MHz - 1.815 MHz	$-20dBm - 10 \cdot \left(\frac{f - f_c}{MHz} - 1,015 \right) dB$	Absolute	30 kHz
1.815 MHz - 2.3 MHz	-28 dBm	Absolute	30 kHz
2.3 MHz - Max	-13 dBm	Absolute	1 MHz

Changeover of the RBW is necessary in this instance. The 1 MHz channel filter is used for the 1 MHz segments.

6.4.2 TSM Norm: Spectrum Emission Mask

Table 6 Maximum output power P < 31 dBm

Offset frequency	Limit	Type/name TDSBCA.LIM	RBW
0.815 MHz - 1.015 MHz	-22 dBm	Absolute	30 kHz
1.015 MHz - 1.815 MHz	-22 - 15·(f_offset - 1.015) dBm	Absolute	30 kHz
1.815 MHz - 2.415 MHz	-36 dBm	Absolute	30 kHz
2.415 MHz - 2.9 MHz	-40 dBm	Absolute	30 kHz
2.9 MHz - Max	-25 dBm	Absolute	1 MHz

Table 7 Maximum output power 31 dBm <= P < 39 dBm

Offset frequency	Limit	Type/name TDSBCA.LIM	RBW
0.815 MHz - 1.015 MHz	P - 53 dBm	Relative	30 kHz
1.015 MHz - 1.815 MHz	P - 53 - 15·(f_offset - 1.015) dBm	Relative	30 kHz
1.815 MHz - 2.415 MHz	P - 67 dBm	Relative	30 kHz
2.415 MHz - 2.9 MHz	P - 71 dBm	Relative	30 kHz
2.9 MHz - Max	P - 56 dBm	Relative	1 MHz

Table 8 Maximum output power 39 dBm <= P < 43 dBm

Offset frequency	Limit	Type/name TDSBCA.LIM	RBW
0.815 MHz - 1.015 MHz	-14 dBm	Absolute	30 kHz
1.015 MHz - 1.815 MHz	-14 - 15·(f_offset - 1.015) dBm	Absolute	30 kHz
1.815 MHz - 2.415 MHz	-28 dBm	Absolute	30 kHz
2.415 MHz - 2.9 MHz	P-71 dBm	Relative	30 kHz
2.9 MHz - Max	P - 56 dBm	Relative	1 MHz

Table 9 Maximum output power P >= 43 dBm

Offset frequency	Limit	Type/name TDSBCA.LIM	RBW
0.815 MHz - 1.015 MHz	-14 dBm	Absolute	30 kHz
1.015 MHz - 1.815 MHz	-14 - 15·(f_offset - 1.015) dBm	Absolute	30 kHz
1.815 MHz - 2.3 MHz	-28 dBm	Absolute	30 kHz
2.3 MHz - Max	-13 dBm	Absolute	1 MHz

LIMIT LINE USER

The *LIMIT LINE USER* softkey activates the entry of user-defined limit lines. The softkey opens the menus of the limit line editor, which may be familiar from the basic unit.

The following limit line settings are recommended for base station tests:

Trace 1, Domain frequency, X-scaling relative, Y-scaling absolute, Spacing linear, Unit dBm.

Unlike the default limit lines on the unit that conform to standard specifications when the analyzer is supplied, a user-specified limit line for the whole frequency range (± 4.0 MHz from the carrier) can only be either relative (to the reference level) or absolute.

The accompanying limit lines of *AUTO* and *MANUAL* modes can also be selected. The names are specified next to the type in the tables above and are defined as follows

Standard: 3GPP:

- Standard in three characters
- Link direction B for base station
- Power class A, B, C, where A is the highest power class
- Type distinction: A for absolute and R for relative

Example for TD-SCDMA and $P < 26$ dBm:

```
TDS   : TD-SCDMA
      B   : base station
      C   : smallest of three power classes
      A: absolute power
=====
TDSBCA.LIM
```

Standard: TSM:

- Standard in three characters
- Link direction B for base station
- Label for TSM standard
- Power class A, B, C, where A is the highest power class
- Type distinction: A for absolute and R for relative

Example for TD-SCDMA and $P < 39$ dBm:

```
TDS   : TD-SCDMA
      B   : base station
      C   : highest of three power classes
      A: absolute power
=====
TDSBCA.LIM
```

The limit line names are stated in the tables next to the type

Remote: see Table of softkeys with assignment of IEC/IEEE bus commands

RESTORE STD LINES

The *RESTORE STD LINES* softkey restores the limit lines defined in the standard to what they were when the unit was supplied. In this way accidental overwriting of the standard lines can be undone.

Remote: CALC:LIM:ESP:REST

LIST EVALUATION

The *LIST EVALUATION* softkey reconfigures the SEM output to a split screen. In the upper half the trace with the limit line is shown. In the lower half the peak value list is shown. For every range of the spectrum emission defined by the standard the peak value is listed. For every peak value the frequency, the absolute power, the relative power to the channel power and the delta limit to the limit line is shown. As long as the delta limit is negative, the peak value is below the limit line. A positive delta indicates a failed value. The results are then colored in red, and a star is indicated at the end of the row, for indicating the fail on a black and white printout.

If the list evaluation is active, the peak list function is not available.

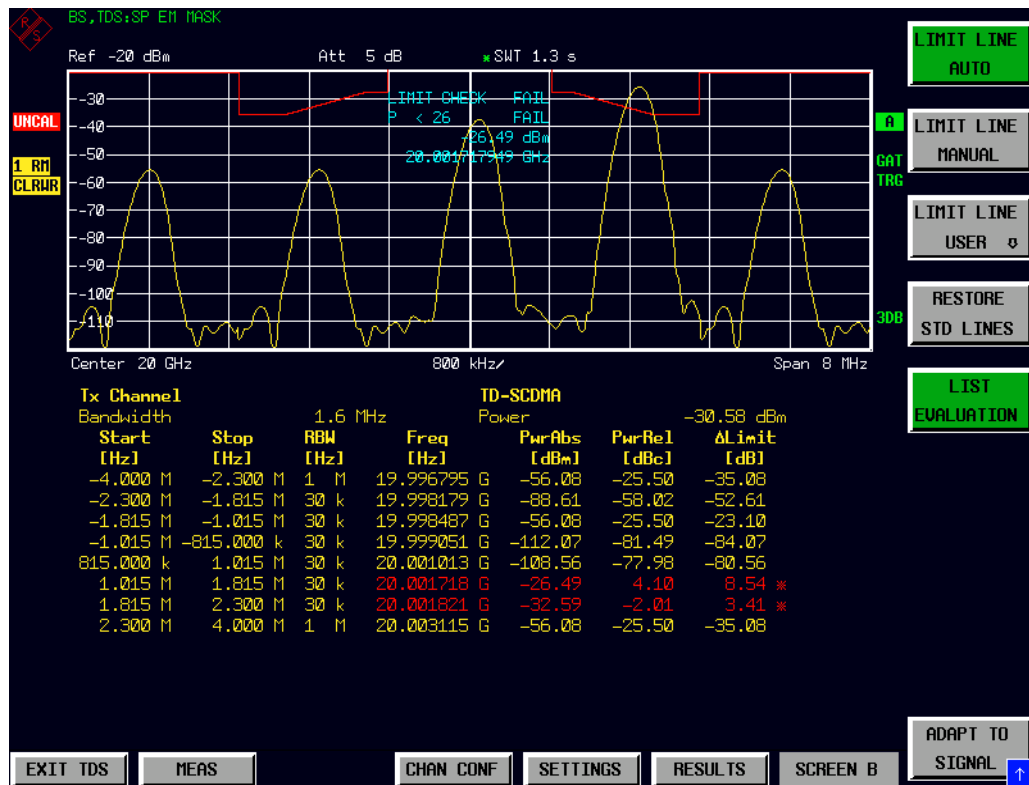

Remote: CALC1:PEAK:AUTO ON | OFF

ADAPT TO SIGNAL

The *ADAPT TO SIGNAL* softkey opens a submenu for matching the reference level of the analyzer and configuration of gated sweep mode.



AUTO LEVEL & TIME

The *AUTO LEVEL & TIME* softkey starts the autorange routine for the reference level. This also creates the relationship between trigger and subframe start.

START SLOT

The *START SLOT* softkey allows entry of the start slot for gated sweep mode. The gated mode is on between *START SLOT* and *STOP SLOT*. For the remaining slots of a subframe the gated mode is off.

STOP SLOT

The *STOP SLOT* softkey allows entry of the stop slot for gated sweep mode. The gated mode is on between *START SLOT* and *STOP SLOT*. For the remaining slots of a subframe the gated mode is off.

```

Remote:  SENS:POW:ACH:AUTO:LTIM
         SENS:POW:ACH:SLOT:START 1...7
         SENS:POW:ACH:SLOT:STOP 1...7
  
```

6.5 Measurement of bandwidth occupied by signal - OCCUPIED BANDWIDTH

The *OCCUPIED BANDWIDTH* softkey activates measurement of the bandwidth occupied by the signal in selected slots.

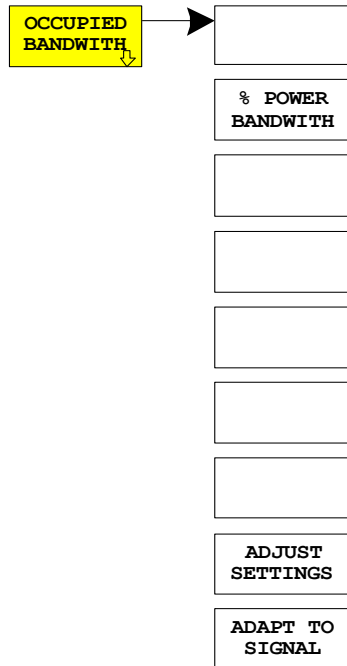

This measurement determines the bandwidth in which - in the initial state - 99% of the signal power is found. The percentage signal power to be included in the bandwidth measurement can be modified. The bandwidth and the frequency markers for measurement are shown in the marker field in the top right corner of the display.

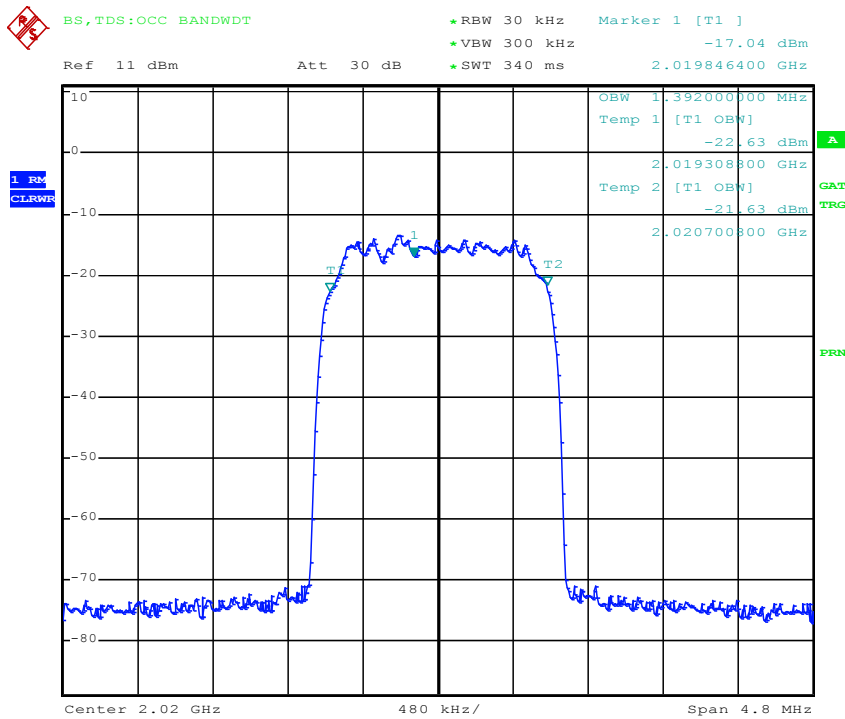

Figure 14 Measuring occupied bandwidth

The softkey activates *SPECTRUM* mode with defined settings:

The following user-specific settings are not modified, so the matching to the device under test is preserved:

- Reference Level + Ref Level Offset
- Center Frequency + Frequency Offset
- Input Attenuation + Mixer Level

OCCUPIED BANDWIDTH	ON
FREQUENCY SPAN	4.8 MHz
RBW	30 kHz
VBW	300 kHz
DETECTOR	RMS
TRIGGER	EXTERN

To restore adapted measurement parameters, the following parameters are saved on exiting and are set again on re-entering this measurement:

- Level parameters
- RBW, VBW
- Sweep time
- SPAN

Remote: CONF:CDP:MEAS OBAN

Result poll: CALC:MARK:FUNC:POW:RES? OBAN

% POWER BANDWIDTH

The *% POWER BANDWIDTH* softkey opens a box for entering the percentage power referred to the total power in the displayed frequency range by which the occupied bandwidth is defined (percentage of total power).

The permissible range is 10 to 99.9 %.

Remote: `SENS:POW:BWID 99PCT`

ADJUST SETTINGS ADJUST SETTINGS

The *ADJUST SETTINGS* softkey matches the analyzer unit settings to the specified channel bandwidth for measurement of the occupied bandwidth.

All analyzer settings relevant to power measurement within a certain frequency range (channel bandwidth) such as:

- Frequency span 3 x channel width
- Resolution bandwidth $RBW \leq 1/40$ of channel bandwidth
- Video bandwidth $VBW \geq 3 \times RBW$
- Detector RMS

are optimized.

The reference level is not influenced by *ADJUST SETTINGS*. It must be set for optimum dynamic range so that the maximum signal is close to the reference level.

Adjustment is performed only once but, if necessary, the unit settings may be changed afterwards.

Remote: `SENS:POW:PRES OBW`

ADAPT TO SIGNAL

The *ADAPT TO SIGNAL* softkey opens a submenu for matching the reference level of the analyzer and configuration of gated sweep mode.

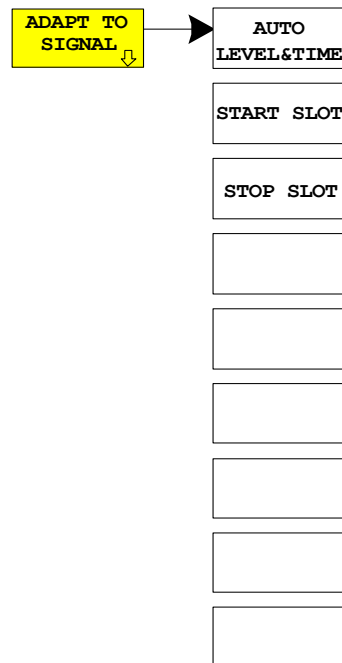

AUTO LEVEL & TIME

The *AUTO LEVEL & TIME* softkey starts the autorange routine for the reference level. This also creates the relationship between trigger and subframe start.

Remote: SENS:POW:ACH:AUTO:LTIM

START SLOT

The *START SLOT* softkey allows entry of the start slot for gated sweep mode. The gated mode is on between *START SLOT* and *STOP SLOT*. For the remaining slots of a subframe the gated mode is off.

Remote: SENS:POW:ACH:SLOT:START 1...7

STOP SLOT

The *STOP SLOT* softkey allows entry of the stop slot for gated sweep mode. The gated mode is on between *START SLOT* and *STOP SLOT*. For the remaining slots of a subframe the gated mode is off.

Remote: SENS:POW:ACH:SLOT:STOP 1...7

6.6 Signal power versus time - POWER VS TIME

The *POWER VS TIME* softkey activates measurement of signal power versus time.

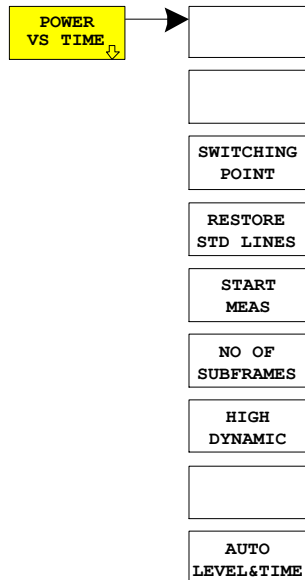

In this measurement the subframe start is determined and the signal power versus time compared with the transmit on/off template of TD-SCDMA specifications. This presents the time segment from the end of slot 0 to the switching point.

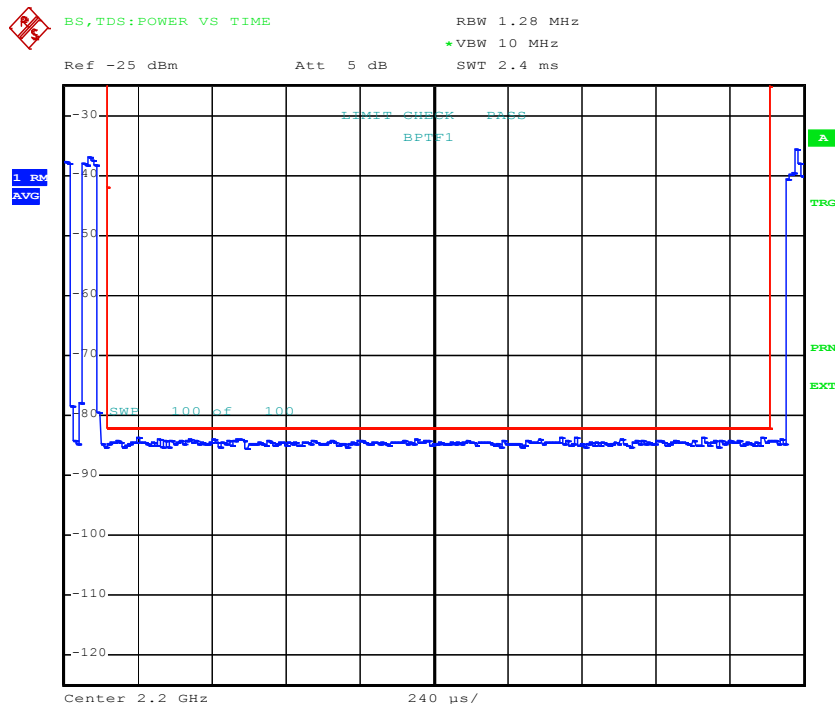

Figure 15 Measuring signal power versus time

The softkey activates *SPECTRUM* mode with defined settings:

The following user-specific settings are not modified, so the matching to the device under test is preserved:

Reference Level + Ref Level Offset
Center Frequency + Frequency Offset
Input Attenuation + Mixer Level

SWEEP TIME	2.4 ms
RBW	1.28 MHz RRC
VBW	10 MHz
DETECTOR	RMS
TRIGGER	EXTERN

To restore adapted measurement parameters, the following parameters are saved on exiting and are set again on re-entering this measurement:

Level parameters
RBW
Sweep time
SPAN

Remote: CONF:CDP:MEAS PVT

Result poll: CALC1:LIM1:FAIL?

SWITCHING POINT

The *SWITCHING POINT* softkey opens an entry box for the number of the last slot in the Off Power time. The switching point defines the boundary between uplink and downlink slots.

Remote: CONF:CDP:PVT:SPO 1...6

RESTORE STD LINES

The *RESTORE STD LINES* softkey restores the limit lines defined in the standard to what they were when the unit was supplied. In this way accidental overwriting of the standard lines can be undone.

Remote: CALC:LIM:PVT:REST

START MEAS

The *START MEAS* softkey starts a single sweep measurement.

Remote: INIT:CONT OFF;:INIT

NO. OF SUBFRAMES

The *NO. OF SUBFRAMES* softkey opens an entry box for the number of subframes to be recorded for the averaging functions.

Remote: CONF:CDP:PVT:SFR <num_value>

HIGH DYNAMIC

The *HIGH DYNAMIC* softkey selects the high dynamic mode. The sweep mode is automatically set to single sweep.

Remote: CONF:CDP:BTS:PVT:HDYN ON|OFF

AUTO LEVEL & TIME

The *AUTO LEVEL & TIME* softkey starts the autorange routine for the reference level. This also creates the relationship between trigger and subframe start.

Remote: SENS:POW:ACH:AUTO:LTIM

6.7 Signal statistic

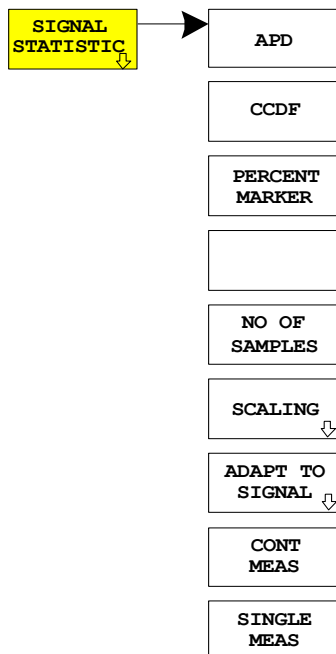

The *SIGNAL STATISTIC* softkey launches measurement of the distribution function of signal amplitudes (complementary cumulative distribution function). The measurement can be switched, using the menu softkey, to amplitude power distribution (APD).

For this measurement, a signal section of settable length is recorded continuously in a zero span, and the distribution of the signal amplitudes is evaluated. The recorded length and the display range of the CCDF can be set using the softkeys of the menu. The amplitude distribution is plotted logarithmically as a percentage of the amount by which a certain level is exceeded, starting with the average value of the signal amplitudes.

In addition, the crest factor, i.e. the difference between the maximum value and the mean power, is displayed in dB.

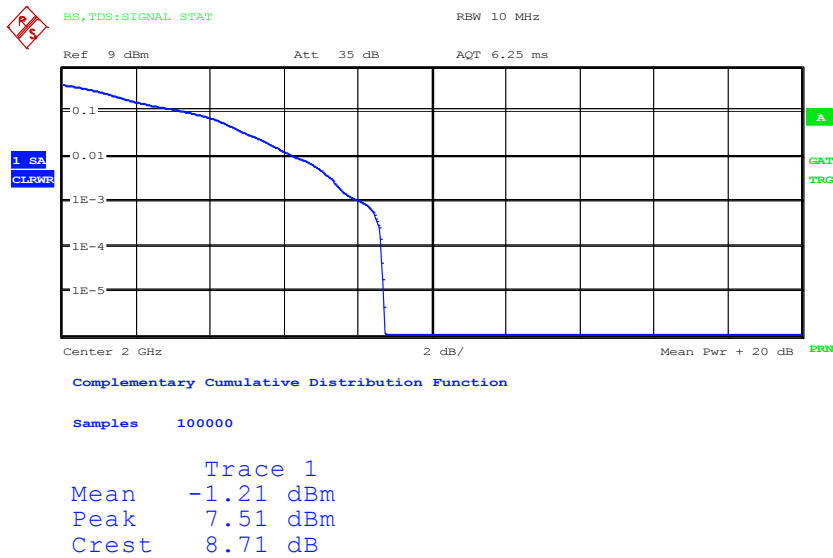

Figure 16 CCDF of TD-SCDMA signal.

The softkey enables SPECTRUM mode with predefined settings:

The following user-specific settings are not modified so that the adaptation to the device under test is preserved:

- Reference Level + Rev Level Offset
- Center Frequency + Frequency Offset
- Input Attenuation + Mixer Level

CCDF	ON
RBW	10 MHz
DETECTOR	SAMPLE
TRIGGER	EXTERN

Departing from this setting, the analyzer can be operated in all the functions it features in SPECTRUM mode, i.e. all measurement parameters can be adapted to a specific measurement.

To restore adapted measurement parameters, the following parameters are saved on exiting and are set again on re-entering this measurement:

- Level parameters
- Sweep time

Remote: CONF:CDP:MEAS CCDF
 or
 CALC:STAT:CCDF ON

Result poll: CALC:MARK:X?
 CALC:STAT:RES? MEAN|PEAK|CFAC|ALL

MEAN mean (r.m.s) measured power in dBm
 in the period of observation
 PEAK measured peak power in dBm
 in the period of observation

CFACtor determined CREST factor (i.e. ratio of peak power to mean power) in dB

ALL results of all three named measurements, separated by a comma:
<mean pow>, <peak pow>,
<crest factor>

APD ON/OFF

The *APD ON/OFF* softkey enables the amplitude probability distribution function .

Remote: CALC:STAT:APD ON

CCDF ON/OFF

The *CCDF ON/OFF* softkey enables the complementary distribution function (complementary cumulative distribution function).

Remote: CALC:STAT:CCDF ON

PERCENT MARKER

When the CCDF function is enabled, the *PERCENT MARKER* softkey supports positioning of marker 1 by entering a sought probability. In this way the power which exceeds a specified probability can be determined in a simple manner.

If marker 1 is disabled, it is enabled automatically.

Remote CALC:MARK:Y:PERC 0...100%

NO OF SAMPLES

The *NO OF SAMPLES* softkey sets the number of power measured values to be taken into account for the calculation of the distribution function.



The overall measurement time is influenced by the selected number of samples as well as by the resolution bandwidth selected for the measurement, since the resolution bandwidth directly affects the sampling rate.

Remote: CALC:STAT:NSAM <value>

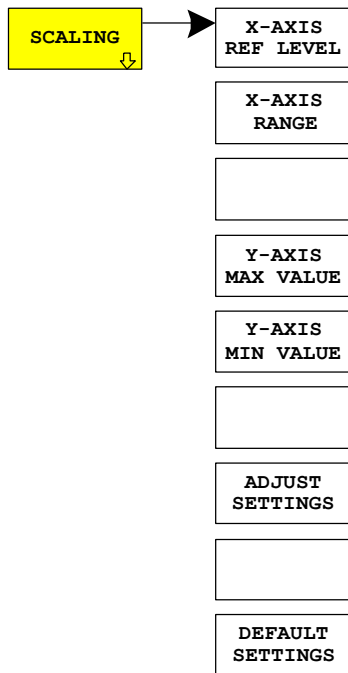

The *SCALING* softkey opens a menu on which the scaling parameters for the X-axis and the Y-axis can be modified.

X-AXIS REF LEVEL

The *X-AXIS REF LEVEL* softkey changes the level settings of the unit and sets the maximum measurable power.

The function is identical to that of the *REF LEVEL* softkey on the *AMPT* menu.

This value is mapped to the right diagram border for the *APD* function. For the *CCDF* function, this value is not directly represented in the diagram because the X-axis is scaled relative to the measured *MEAN POWER*.

Remote: `CALC:STAT:SCAL:X:RLEV <value>`

X-AXIS RANGE

The *X-AXIS RANGE* softkey changes the level range that is to be covered by the distribution sampling function.

The function is identical to that of the *RANGE LOG MANUAL* softkey on the *AMPT* menu.

Remote: `CALC:STAT:SCAL:X:RANG <value>`

Y-AXIS MAX VALUE

The *Y-AXIS MAX VALUE* softkey sets the upper limit of the displayed probability range.

The values on the Y-axis are normalized, i.e. the maximum value is 1.0. Since the Y-axis scaling is logarithmic, the spacing between the maximum and minimum values must be at least one decade.

Remote: `CALC:STAT:SCAL:Y:UPP <value>`

Y-AXIS MIN VALUE

The *Y-AXIS MIN VALUE* softkey sets the lower limit of the displayed probability range.

Since the Y-axis scaling is logarithmic, the spacing between the maximum and minimum values must be at least one decade. Permissible range $0 < \text{value} < 1$.

Remote: `CALC:STAT:SCAL:Y:LOW <value>`

ADJUST SETTINGS

The *ADJUST SETTINGS* softkey optimizes the analyzer level settings according to the measured peak power in order to gain maximum sensitivity of the unit.

The level range is set for the APD measurement according to the measured distance between the power peak value and the minimum value and for the CCDF measurement between the power peak value and the mean value in order to achieve maximum power resolution.

In addition, the probability scale is adapted to the selected number of samples.

Remote: `CALC:STAT:SCAL:AUTO ONCE`

DEFAULT SETTINGS

The *DEFAULT SETTINGS* softkey resets the scaling on the X-axis and the Y-axis to the default (PRESET) settings.

X-axis reference level: -20 dBm
X-axis range for APD: 100 dB
X-axis range for CCDF: 20 dB

Y-axis for upper limit: 1.0
Y-axis for lower limit: 1E-6

Remote: `CALC:STAT:PRES`



The *ADAPT TO SIGNAL* softkey opens a submenu for matching the reference level of the analyzer and configuration of gated sweep mode.

AUTO LEVEL&TIM

The *AUTO LEVEL & TIME* softkey starts the autorange routine for the reference level. This also creates the relationship between trigger and subframe start.

Remote: SENS:POW:ACH:AUTO:LTIM

START SLOT

The *START SLOT* softkey allows entry of the start slot for gated sweep mode. The gated mode is on between *START SLOT* and *STOP SLOT*. For the remaining slots of a subframe the gated mode is off.

Remote: SENS:POW:ACH:SLOT:START 1...7

STOP SLOT

The *STOP SLOT* softkey allows entry of the stop slot for gated sweep mode. The gated mode is on between *START SLOT* and *STOP SLOT*. For the remaining slots of a subframe the gated mode is off.

Remote: SENS:POW:ACH:SLOT:STOP 1...7

CONT MEAS

The *CONT MEAS* softkey starts the collection of new sequences of sample data and the calculation of the APD or CCDF trace, depending on the selected measurement. The next measurement is started automatically as soon as the indicated number of samples has been reached ("CONTinuous MEASurement").

```
Remote:  INIT:CONT ON;
         INIT:IMM
```

SINGLE MEAS

The *SINGLE MEAS* softkey starts the collection of one new sequence of sample data and the calculation of the APD or CCDF trace, depending on the selected measurement. The measurement terminates when the indicated number of samples is reached.

```
Remote:  INIT:CONT OFF;
         INIT:IMM
```

6.8 Code domain measurements on TD-SCDMA signals

The Application Firmware R&S FS-K76 features a code domain analyzer. This can be used for the measurements required by TD-SCDMA specifications for the power of the various codes and code channels (concentrated codes). In addition, the modulation quality (EVM and RHO factor), frequency errors, chip timing errors and peak code domain errors are determined. Constellation and bit stream evaluations are also available.

Use of an external trigger signal enables determination of the trigger-to-subframe time. The number of observed slots can be set with the *CAPTURE LENGTH* softkey.

Basically, the firmware differentiates between the following result classes for the evaluations:

- Results that consider the total signal over the whole observation period (all slots).
- Results that consider the total signal over one slot.
- Results that consider one channel over the whole observation period (all slots).
- Results that consider one channel over one slot.

The evaluations of the code domain analyzer are performed on a split screen. The screen is divided into two halves for this purpose.

The upper half of the screen (screen A) displays evaluations that vary by code. The lower half of the screen (screen B) displays all other evaluations.

Table 10 Evaluation on screen A

Evaluation on screen A	All channels	One channel	All slots	One slot
Code domain power	✓			✓
Code domain error power	✓			✓
Channel table	✓			✓

Table 11 Evaluation on screen B

Evaluation on screen B	All channels	One channel	All slots	One slot
Result summary	✓	✓	✓	✓
Power versus slot		✓	✓	
Power versus symbol		✓		✓
Composite EVM (modulation accuracy)	✓		✓	
Composite Constellation	✓			✓
Peak code domain error	✓		✓	
Symbol constellation		✓		✓
Symbol EVM		✓		✓
Bit stream		✓		✓

Depending on the symbol rate of a code channel, it has a different spreading factor and a different number of symbols per slot. The relationship can be seen in the table below.

Table 12 Relationship between spreading factor and symbol count plus data rate

Spreading factor	Symbols per slot	Data rate [kbps] QPSK	Data rate [kbps] 8PSK
16	44	17.6	26.4
8	88	35.2	52.8
4	176	70.4	105.6
2	352	140.8	211.2
1	704	281.6	422.4

The data rates in the table result from the bits per slot referred to a subframe length of 5 ms. In evaluation on the bottom screen, which uses symbols on the X axis, the maximum number of symbols varies with the symbol rate of the selected code channel.

Using the *SELECT CHANNEL* and *SELECT SLOT* softkeys, you can select the code channel and slot for which you want to display a result. In an example, code channel 1.16 is selected (code number 1 for spreading factor 16) and slot 2. Evaluation of code domain power is active on screen A and symbol EVM evaluation on screen B. So screen A shows the code domain power evaluation of slot 2. Code channel 1.16 is selected and shown in red. On the lower half of the screen you can see the symbol EVM evaluation of code channel 1.16 in slot 2 with 44 corresponding values.

The code domain analyzer can work in two modes. In *CODE CHAN AUTOSEARCH* mode it automatically searches for active channels in the whole code domain.

In the other mode, *CODE CHAN PREDEFINED*, you can determine the active code channels of a random slot by selectable and editable tables. The automatic channel search is then replaced by this user entry in the selected slot.

The code domain analyzer requires an active channel 1.16 (e.g. P-CCPCH1) and a valid midamble in slot 0 for synchronization. The parameters *SCRAMBLING CODE* and *MA SHIFTS CELL* must comply with the base station.

6.9 Presentation of evaluations - RESULTS

The *RESULTS* hotkey or the *MEAS* hotkey and then the *CODE DOM ANALYZER* softkey .

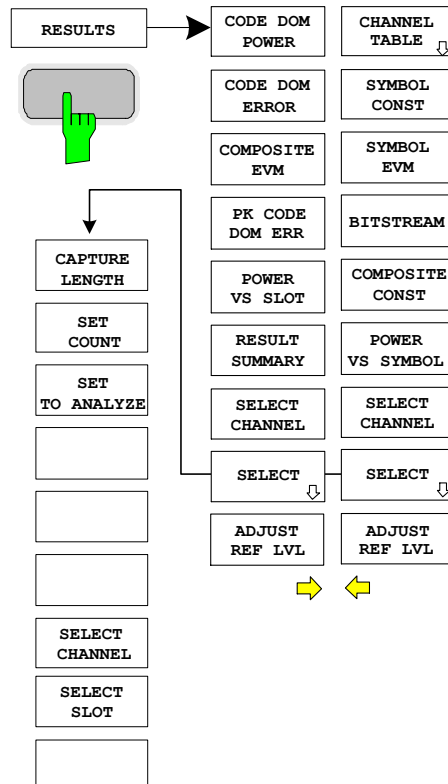

The *RESULTS* hotkey opens the submenu for choosing evaluation. The main menu shows the major evaluations for fast access; more detailed evaluations are available in the page menu.

You can choose from the following evaluations:

CODE DOM POWER

Code domain power evaluation, depending on the *CODE PWR ABS / REL* softkey in relative or absolute scaling

CODE DOM ERROR

Code domain error power evaluation

COMPOSITE EVM

Error vector magnitude evaluation for each slot

PK CODE DOM ERR

Peak of code domain error power evaluation for each slot

POWER VS SLOT

Power of selected channel over all slots, depending on the *CODE PWR ABS / REL* softkey in relative or absolute scaling

RESULT SUMMARY	Results in tabular form
CHANNEL TABLE	Channel occupancy table in code order or midamble order
SYMBOL CONST	Symbol constellation evaluation
SYMBOL EVM	Error vector magnitude evaluation for each symbol of a slot
BIT STREAM	Display of decided bits
COMPOSITE CONST	Composite constellation evaluation

With the SELECT SLOT softkey you can select a slot for the evaluations CODE DOM POWER, CODE DOM ERROR, CHANNEL TABLE, SYMBOL CONST, SYMBOL EVM, BIT STREAM and POWER VS SYMBOL.

With ADJUST REF LVL you can optimally match the reference level of the unit to the signal level.

The following user-specific settings are not modified, so the matching to the device under test is preserved:

Reference Level + Ref Level Offset
Center Frequency + Frequency Offset
Input Attenuation + Mixer Level

The following user-specific settings are adopted as follows:

External trigger source is kept, all other trigger sources result in free run mode.
Additional trigger settings are preserved.

To restore adjusted level parameters, they are saved on exiting the code domain analyzer and reset on re-entering the code domain analyzer.

The major measurement settings on which displays are based are summarized at the top of the diagram:

BS, TDS	:CODE POWER	DR	17.6 kbps
		Chan	1.16
dB TOT	CF 2.01000 GHz	Slot	0

Figure 17 Function fields of diagrams

The meanings are as follows:

- Column: Mobile radio system (base station TD-SCDMA) BS, TDS
Name of selected evaluation: e.g. CODE POWER
(blank line)
Unit of Y axis e.g. dB TOT for relative power to total power
- Column: (blank line)
(blank line)
Center frequency of signal: e.g. CF 2.01000 GHz
- Column: Data rate of selected channel: e.g. DR 17.6 kbps
Code number and spreading factor of selected channel: e.g. Chan 1.16
Number of selected slot: Slot 0

CODE DOM POWER

The *CODE DOM POWER* softkey selects evaluation of the code domain power (CDP).

In code domain power evaluation, the total signal is considered over precisely one slot. The power values of the different codes are determined and plotted in a diagram. In this diagram, the X axis is the code number and the Y axis a logarithmic level axis. The number of codes corresponds to the maximum spreading factor 16. You can set the slot to be evaluated with the *SELECT SLOT* softkey.

With the *CODE PWR ABS / REL* softkey you can switch between absolute and relative power readout. In relative power readout, the code power is referred to the mean total power of the data fields of the selected slot. The units of the Y axis are consequently dBm for absolute and dB TOT for relative evaluation.

The power values of the active and the unoccupied channels are shown in different colours. The following colours are defined:

- Yellow active channel
- Cyan unoccupied
- Red selected channel

A channel in *CODE CHAN AUTOSEARCH* mode (automatic channel search mode) is referred to as active if the minimum relative power you enter (see *INACT CHAN THRESHOLD* softkey) is exceeded and there is adequate signal/noise ratio. In *CODE CHAN PREDEFINED* mode, each code channel in the user-defined channel table is identified as active.

The results of code domain power evaluation are sorted and shown in ascending order of code numbers. All codes are projected to the spreading factor 16 for sorting. So channel 2.8 is between channels 3.16 and 6.16 for example.

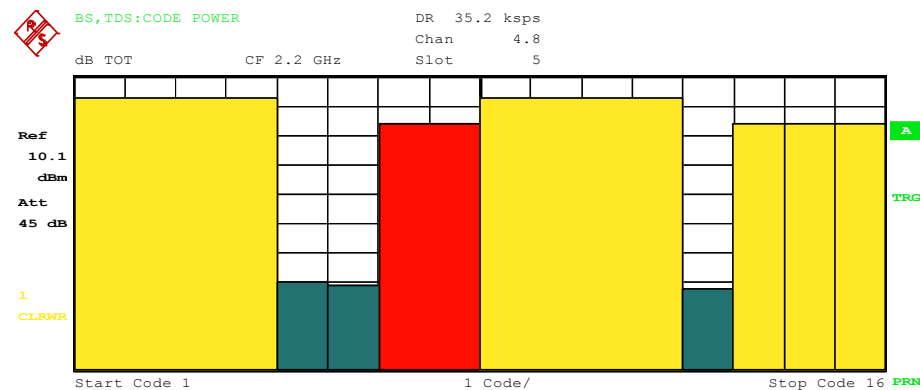

Figure 18 CDP diagram

By entering a channel number (see *SELECT CHANNEL* softkey), you can select a channel for more detailed display. The codes of this channel are shown in red.

Selection of more detailed evaluations (e.g. *SYMBOL CONST*) for unoccupied codes is possible but not meaningful since the results are not valid.

```
Remote:  CALC1:FEED "XPOW:CDP:RAT" (relative)
         CALC1:FEED "XPOW:CDP" (absolute)
```

CODE DOM ERROR

The *CODE DOM ERROR* softkey selects evaluation of code domain error power (CDEP).

The code domain error power measurement reads out the difference in power between a measured and an ideally generated reference signal for each code in dB. This is an error power, so active and inactive channels can be judged jointly at a glance in this evaluation. Analysis is solely in spreading factor 16.

In code domain error power evaluation, the total signal is considered over precisely one slot, the error power of the different codes is determined and plotted in a diagram. In this diagram, the X axis is the code number and the Y axis a logarithmic level axis with units of dB. The number of codes on the X axis corresponds to the maximum spreading factor 16. You can set the slot to be evaluated with the *SELECT SLOT* softkey.

The power values of the active and the unoccupied channels are shown in different colours. The following colours are defined:

- Yellow active channel
- Cyan unoccupied
- Red selected channel

A channel in *CODE CHAN AUTOSEARCH* mode (automatic channel search mode) is referred to as active if the minimum relative power you enter (see *INACT CHAN THRESHOLD* softkey) is exceeded and there is adequate signal/noise ratio. In *CODE CHAN PREDEFINED* mode, each code channel in the user-defined channel table is identified as active.

The results of code domain error power evaluation are sorted and shown in ascending order of code numbers in spreading factor 16.

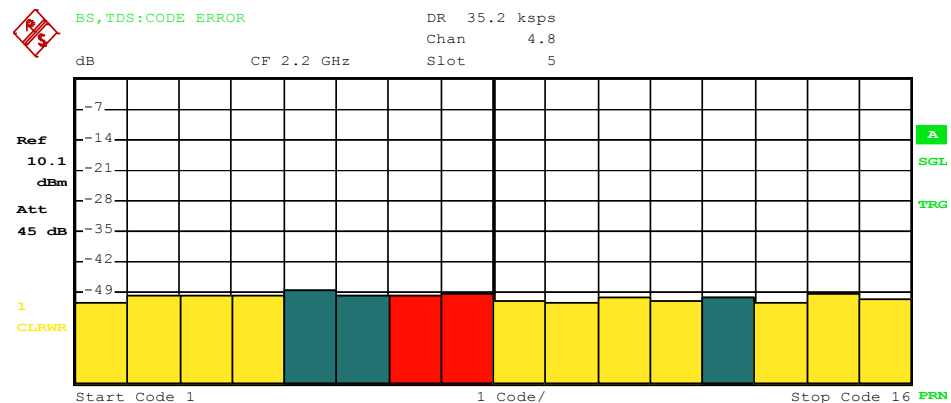

Figure 19 CDEP diagram

By entering a channel number (see *SELECT CHANNEL* softkey), you can select a channel for more detailed display. The codes of this channel are shown in red.

Remote: CALC1:FEED "XPOW:CDEP"

COMPOSITE EVM

The *COMPOSITE EVM* softkey selects evaluation of error vector magnitude (EVM) over the total signal (modulation accuracy).

In composite EVM measurement, the square root is calculated from the squared error between the real and imaginary parts of the test signal and an ideally generated reference signal and normalized to the square root of the mean power of the reference signal.

The measured result consists of one composite EVM value per slot. You can set the number of slots by the *CAPTURE LENGTH* softkey. Subsequently, composite EVM evaluation considers the total signal over the entire period of observation. No EVM value is output for inactive slots because there is no reference power present. Only the channels detected as active are used to generate the ideal reference signal. In the case of a channel that is not detected as active because of low power for instance, the difference between the test signal and the reference signal and the composite EVM is therefore very large (see figure).

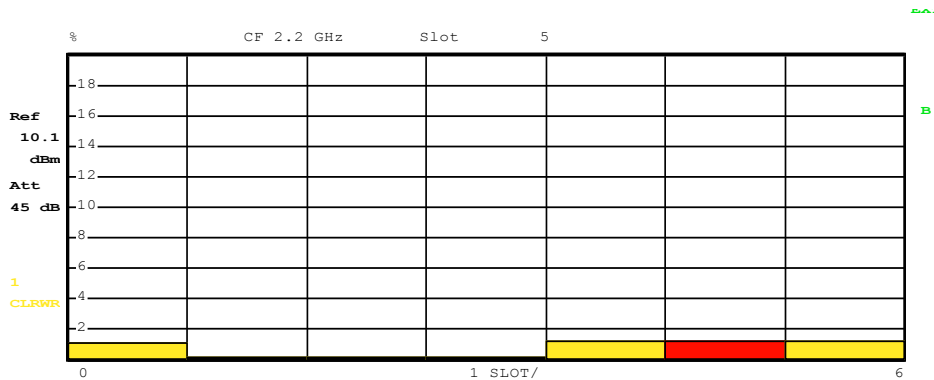

Figure 20 Composite EVM diagram

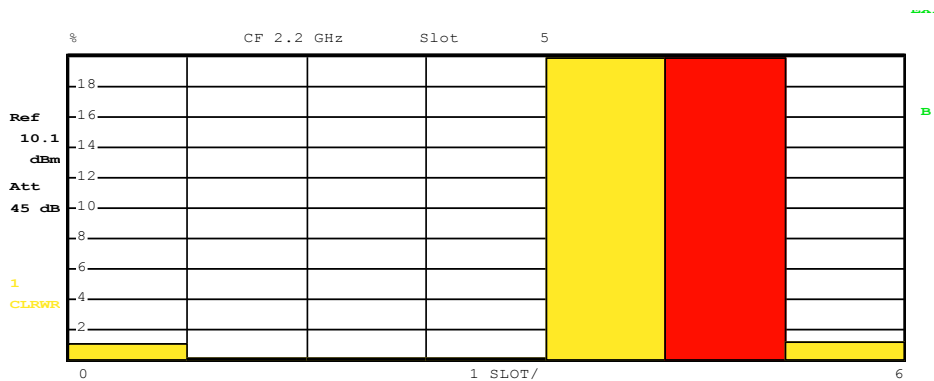

Figure 21 Composite EVM diagram with unrecognized channels

Similar to selecting a code channel in the CDP or CDEP diagram, there is the option in the composite EVM diagram of selecting a slot. You select by entering the slot number (see *SELECT SLOT* softkey). The selected slot appears as a red bar.

Remote: CALC2:FEED "XTIM:CDP:MACC"

PK CODE DOM ERR

The *PK CODE DOM ERR* softkey selects peak code domain error evaluation.

The peak code domain error measurement reads out the maximum of the code domain error power measurement for each slot. This determines the difference in power between a measured and an ideally generated reference signal for each code in dB. Analysis is solely in spreading factor 16.

The measured result consists of a numeric value per slot for the peak code domain error. You can set the number of slots by the *CAPTURE LENGTH* softkey.

Subsequently, peak code domain error evaluation considers the total signal over the entire period of observation. No peak code domain error value is output for inactive slots because there is no reference power present.

Only the channels detected as active are used to generate the ideal reference signal for peak code domain error. If an occupied code is not detected as active because of low power, the difference between the test signal and the reference signal is very large. The R&S FS-K76 therefore shows a peak code domain error that is too high (see figure).

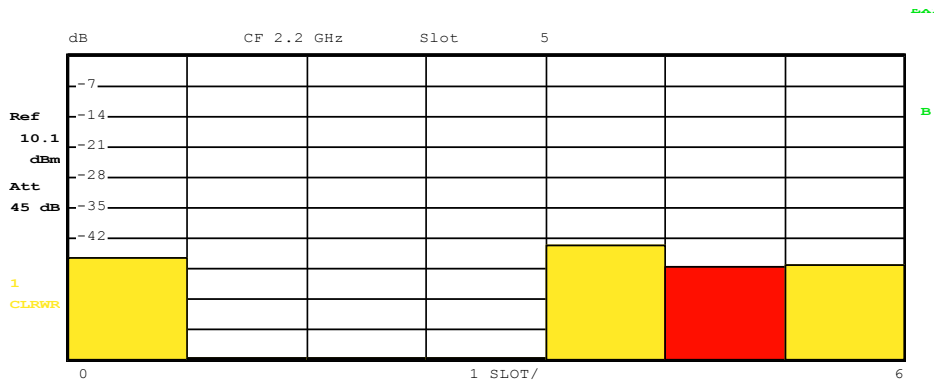

Figure 22 Peak code domain error diagram

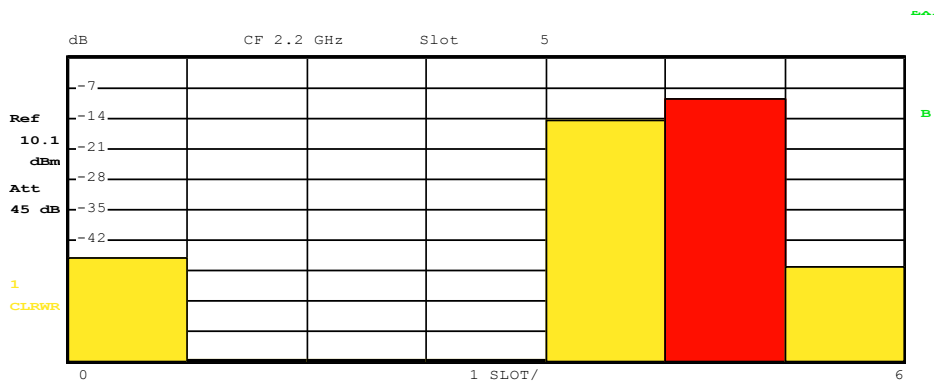

Figure 23 Peak code domain error diagram with unrecognized channels

Similar to selecting a code channel in the CDP or CDEP diagram, there is the option in the peak code domain error diagram of selecting a slot. You select by entering the slot number (see *SELECT SLOT* softkey). The selected slot appears as a red bar.

Remote: CALC2:FEED "XTIM:CDP:ERR:PCD"

POWER VS SLOT

The *POWER VS SLOT* softkey activates power versus slot evaluation.

The power of the selected channel for each slot is averaged. With the *CODE PWR ABS / REL* softkey you can switch between absolute and relative power readout. In relative power readout, the code power in each slot is referred to the mean total power of the data fields of the slot. The units of the Y axis are consequently dBm for absolute and dB TOT for relative evaluation.



In relative power readout, the noise power in inactive slots of the selected channel is normalized to the total noise power. This produces relative power of typically -12 dB in inactive slots.

Colours indicate whether the selected channel in the particular slot is active, inactive or alias power of another channel. Alias power is indicated if there is a channel with a different spreading factor in the place of the selected channel. The following colours are defined:

- Yellow active channel
- Cyan unoccupied
- Green alias power
- Red selected channel

The measured result consists of a numeric value per slot for the power value. You can set the number of slots by the *CAPTURE LENGTH* softkey. Subsequently, power versus slot evaluation considers one code channel over the entire period of observation.

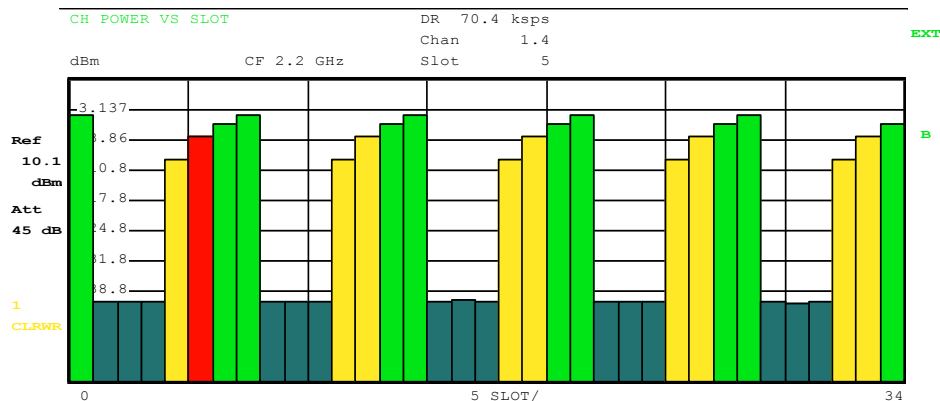

Figure 24 Peak versus slot diagram with absolute power readout

Similar to selecting a code channel in the CDP or CDEP diagram, there is the option in the power versus slot diagram of selecting a slot. You select by entering the slot number (see *SELECT SLOT* softkey). The selected slot appears as a red bar.

```
Remote:  CALC2:FEED "XTIM:CDP:PVSL:REL" (relative)
         CALC2:FEED "XTIM:CDP:PVSL:ABS" (absolute)
```

For compatibility reason with other 3G applications the default node `CALC2:FEED` 'XTIM:CDP:PVSL[:ABS]' is changed to `CALC2:FEED` 'XTIM:CDP:PVSL[:RAT]' since version 2.60/3.50.

RESULT SUMMARY

The *RESULT SUMMARY* softkey selects numeric evaluation of all measured results. Evaluation is subdivided as follows:

RESULT SUMMARY TABLE		DR	52.8 kbps
		Chan	1.16
		Slot	4
		CF	1 GHz
GLOBAL RESULTS FOR SET 0:			
Ref	Chip Rate Error	0.05 ppm	Trg to Frame 59 ns
-6.00 dBm	SLOT RESULTS		
	P Data	-10.75 dBm	Carr Freq Err -38.40 Hz
Att	P D1	-11.30 dBm	IQ Imbal/Offs 0.03/0.05 %
20 dB	P D2	-10.27 dBm	RHO 1.0000
	P Midamble	-10.19 dBm	Composite EVM 0.18 %
	Active Channels	2	Pk CDE(SF 16) -62.68 dB
			Average RCDE -59.75 dB
1	CHANNEL RESULTS		
CLRWR	Channel.SF	1.16	Data Rate 52.8 kbps
	ChannelPwr Rel	-3.01 dB	ChannelPwr Abs -13.76 dBm
	Symbol EVM	0.10 %rms	Symbol EVM 0.31 %Pk

Figure 25 Result summary

The first part shows measured results relating to the total signal:

- Chip Rate Error: Chip rate error (1.28 Mcps) in ppm. A high chip rate error results in symbol errors and possibly in the CDP measurement not being able to synchronize.
- Trg to Frame: Time offset from start of recorded signal segment to start of first slot. In the case of triggered data recording, this corresponds to the time offset from trigger to subframe start (+ trigger offset). If the analyzer was unable to synchronize to the TD-SCDMA signal, the value of Trg to Frame is meaningless. If the *FREE RUN* trigger is selected, dashes (--) are shown.

The second part shows measured results relating to all channels for the slot selected with the *SELECT SLOT* softkey:

- P Data: Total power of data fields for selected slot
- PD1/PD2: Power of data fields 1 and 2 for selected slot
- P Midamble: Power of midamble field for selected slot
- Active Channels: Number of active channels for selected slot
- Carr Freq Err: Frequency error for selected slot. This is the sum of the frequency error of the analyzer and that of the device under test.
- IQ Imbal/Offs: IQ imbalance and IQ DC offset
- RHO: Quality parameter RHO for selected slot
- Composite EVM: Total signal error vector magnitude for selected slot.
- Pk CDE (SF 16) : Peak code domain error in spreading factor 16 for selected slot

The third part of *RESULT SUMMARY* shows the results of measurements on the selected channel in the selected slot.

- Data Rate: Data rate as a function of spreading factor and modulation class of channel
- Channel SF: Number of channel and its spreading factor
- Channel Power Rel: Relative channel power referred to mean power of data fields of selected slot
- Average RCDE: Average relative code domain error of the active channels
- Channel Power Abs: Absolute channel power
- Symbol EVM: Peak and mean EVM for selected channel in selected slot

```
Remote:  CALC2:FEED "XTIM:CDP:ERR:SUMM
          CALC2:MARK1:FUNC:CDP:BTS:RES?
          SLOT | PDAT | PD1 | PD2 | PMID | RHO | MACC | PCD |
          FERR | CERR | TFR | IQIMB | IQOF | ACT | SRAT | CHAN |
          SFAC | CDPR | CDP | EVMR | EVMP | ARCD
```

CHANNEL TABLE

The *CHANNEL TABLE* softkey selects channel occupancy table evaluation.

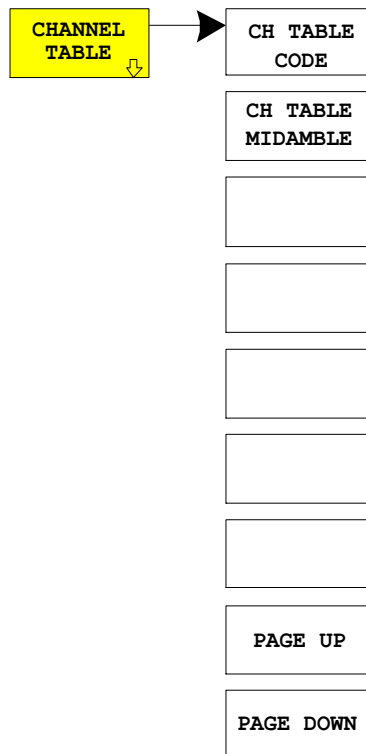

The channel occupancy table can hold a maximum of 32 entries, corresponding to 16 midambles and 16 code channels. Channel occupancy table evaluation considers the total signal over precisely one slot. You set the slot to be evaluated by the *SELECT SLOT* softkey.

A data channel in *CODE CHAN AUTOSEARCH* mode is identified as active if it exhibits minimum power (see *INACT CHAN THRESHOLD* softkey) and adequate signal/noise ratio. In *CODE CHAN PREDEFINED* mode, all active code channels contained in the predefined channel table are identified as active in the selected slot.

You can select the sorting of the channel table with the *CH TABLE CODE* and *CH TABLE MIDAMBLE* softkeys.

The midambles are listed first in code order. The midambles are sorted in ascending order by their midamble shift. They are followed by the active channels. The active channels are projected to the spreading factor 16 and sorted in ascending order of code numbers.

The inactive channels come at the end.

 BS,TDS:CHANNEL TAB

Chan 1.4
Slot 5

CF 15.36 MHz

	Type	Chan.SF	Data Rate kbps	Mod Type	Pwr.Abs dBm	Pwr.Rel dB	MA.shift	ΔMid1 dB	ΔMid2 dB	
Ref	Midamble	---	---	---	-9.51	-4.78	1	-0.03	-0.04	A
4.00	Midamble	---	---	---	-15.53	-10.80	7	0.05	0.02	
dBm	Midamble	---	---	---	-9.50	-4.77	9	0.04	0.05	
Att	Midamble	---	---	---	-15.52	-10.78	14	-0.02	-0.01	TRG
35 dB	Midamble	---	---	---	-15.54	-10.80	15	-0.01	-0.02	
	Midamble	---	---	---	-15.53	-10.79	16	-0.05	-0.04	
1	DPCH	1.4	70.40	QPSK	-9.47	-4.74	1	---	---	
CLRWR	DPCH	4.8	35.20	QPSK	-15.57	-10.84	7	---	---	
	DPCH	3.4	70.40	QPSK	-9.55	-4.82	9	---	---	
	DPCH	14.16	17.60	QPSK	-15.50	-10.76	14	---	---	

PRN

Figure 26 Channel table in code order

In midamble order the codes are listed after each midamble. Common and default midamble allocation is automatically distinguished. The allocation of codes to midambles for these two cases can be taken from TD-SCDMA specifications. If neither a common nor a default midamble allocation is found, sorting is in code order.

 BS,TDS:CHANNEL TAB

Chan 1.4
Slot 5

CF 15.36 MHz

	Type	Chan.SF	Data Rate kbps	Mod Type	Pwr.Abs dBm	Pwr.Rel dB	MA.shift	ΔMid1 dB	ΔMid2 dB	
Ref	Midamble	---	---	---	-9.51	-4.78	1	-0.04	-0.04	A
4.00	DPCH	1.4	70.40	QPSK	-9.47	-4.74	1	---	---	
dBm	Midamble	---	---	---	-15.52	-10.80	7	0.05	0.03	
Att	DPCH	4.8	35.20	QPSK	-15.56	-10.83	7	---	---	TRG
35 dB	Midamble	---	---	---	-9.50	-4.77	9	0.04	0.05	
	DPCH	3.4	70.40	QPSK	-9.54	-4.81	9	---	---	
	Midamble	---	---	---	-15.51	-10.78	14	-0.03	-0.01	
1	DPCH	14.16	17.60	QPSK	-15.49	-10.77	14	---	---	
CLRWR	Midamble	---	---	---	-15.53	-10.80	15	-0.01	-0.02	
	DPCH	15.16	17.60	QPSK	-15.51	-10.79	15	---	---	

PRN

Figure 27 Channel table in midamble order

The following parameters are determined by CDP measurement for the channels:

- Type: Type of channel (midamble, DPCH or special channel)
- Chan SF: Channel number (1 to spreading factor) including spreading factor of channel in Notation Chan SF
- Data Rate: Data rate at which channel is transmitted

Mod Type: Modulation method of channel (QPSK or 8PSK)

Pwr Abs/Pwr Rel:

Absolute and relative power of channel (referred to total power of data fields)

Ma Shift: Midamble shift. For code channels, this is the shift of the associated midamble if a common or default midamble allocation is detected.

TD-SCDMA specifications state that a midamble and its code channels must exhibit the same power. The following two parameters are shown if a common or default midamble allocation is detected.

Δ MiD1: Power offset between midamble and sum power of its channels in data field 1

Δ MiD2: Power offset between midamble and sum power of its channels in data field 2

A data channel in *CODE CHAN AUTOSEARCH* mode is identified as active if it exhibits minimum power (see *INACT CHAN THRESHOLD* softkey) and adequate signal/noise ratio. In *CODE CHAN PREDEFINED* mode, all active code channels contained in the predefined channel table are identified as active.

```
Remote:  CALC1:FEED "XTIM:CDP:ERR:CTAB"
          CONF:CDP:CTAB:ORD CODE
          CONF:CDP:CTAB:ORD MID
```

SYMBOL CONST

The *SYMBOL CONST* softkey selects evaluation of the constellation diagram at symbol level. The diagram is normalized by the square root of the mean symbol power.

Evaluation of the symbols is performed for the selected channel (*SELECT CHANNEL* softkey) and the selected slot (*SELECT SLOT* softkey). This evaluation consequently considers results of one channel for one slot.

For orientation, the unit circle is added to the figure.

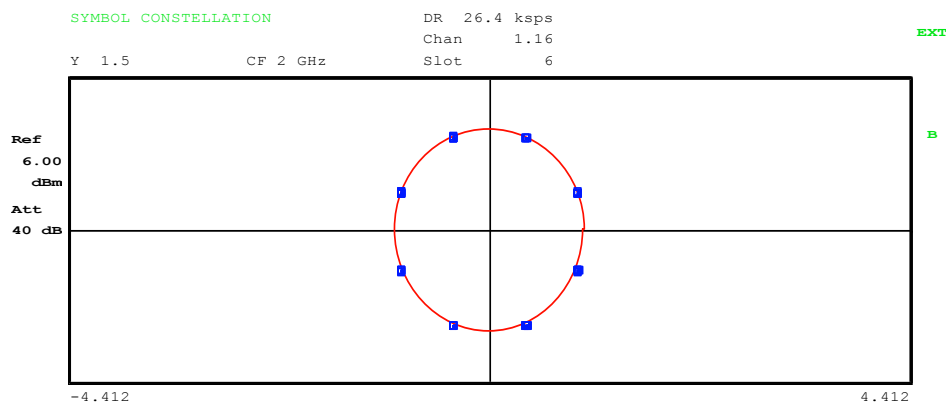

Figure 28 Symbol constellation diagram for 8PSK modulation

```
Remote:  CALC2:FEED "XTIM:CDP:SYMB:CONS"
```

SYMBOL EVM

The *SYMBOL EVM* softkey selects symbol error vector magnitude evaluation. Evaluation of the EVM is performed for the selected channel (*SELECT CHANNEL* softkey) and the selected slot (*SELECT SLOT* softkey). This evaluation consequently considers results of one channel for one slot.

Evaluation of symbol error vector magnitude for unoccupied codes is not meaningful, since the results are not valid.

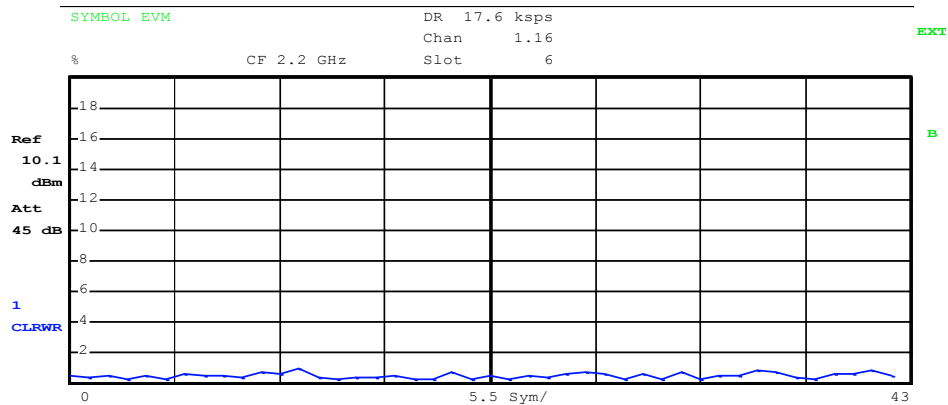

Figure 29 Error vector magnitude for one channel of slot

Remote: CALC2:FEED "XTIM:CDP:SYMB:EVM"

BIT STREAM

The *BIT STREAM* softkey selects evaluation of the bit stream from the demodulated received signal.

Evaluation of the decided bits is performed for the selected channel (*SELECT CHANNEL* softkey) and the selected slot (*SELECT SLOT* softkey). This evaluation consequently considers results of one channel for one slot.

Depending on the spreading factor of the channel, a slot may contain between 44 and 704 symbols. In QPSK modulated channels, a symbol always consists of two bits. In 8PSK modulated channels, a symbol always consists of three bits. The allocation of symbols to bits is according to TD-SCDMA specifications.

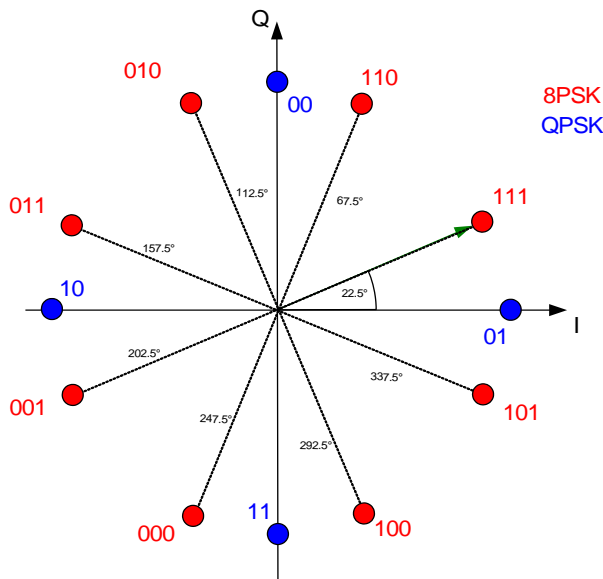

Figure 30 Phasor diagram for QPSK and 8PSK including bit values

The marker can be used to scroll in the bit stream.

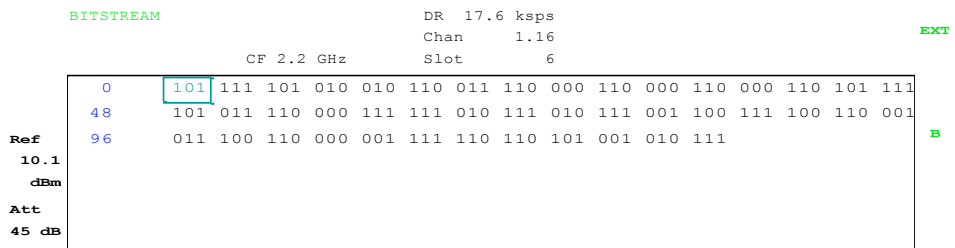

Figure 31 Demodulated bits for channel with 8PSK modulation

Remote: CALC2:FEED "XTIM:CDP:BSTR"

COMPOSITE CONST

The *COMPOSITE CONST* softkey selects the evaluation of the constellation diagram at chip level.

With *COMPOSITE CONST*, the total signal is taken into account over the selected slot (*SELECT SLOT* softkey). A constellation point is entered in the diagram for each of the 704 data chips. The diagram is normalized by the square root of the mean chip power.

For orientation, the unit circle is added to the figure.

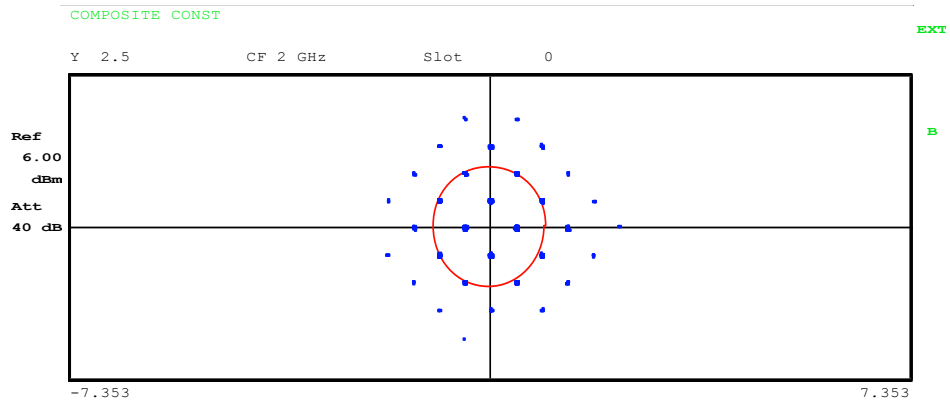

Figure 32 Composite Constellation Diagram



If only one channel is active in the selected slot, all constellation points are situated on the unit circle and occupy one display pixel, if noise is low. If so, it would be reasonable to switch to symbol constellation for a better view.

Remote: CALC2:FEED "XTIM:CDP:COMP:CONS"

POWER VS SYMBOL

The *POWER VS SYMBOL* softkey selects power versus symbol evaluation. Evaluation outputs the absolute power in dBm at every symbol time for the selected channel (*SELECT CHANNEL* softkey) in the selected slot (*SELECT SLOT* softkey). This evaluation consequently considers results of one channel for one slot.

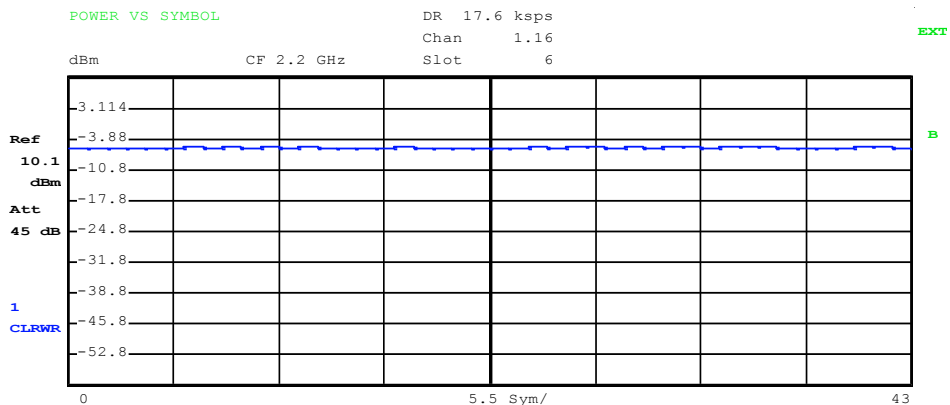

Figure 33 Power versus symbol for one channel of one slot

Remote: CALC2:FEED "XTIM:CDP:PVSY"

SELECT

The *SELECT* softkey opens a submenu to define the capture configuration and the selection of slot and channel for the evaluation.

CAPTURE LENGTH

The *CAPTURE LENGTH* softkey allows entry of the number of slots to be captured. The range is from 2 to 63. For all evaluations with one value per slot on the X axis, the maximum value on the X axis is the set *CAPTURE LENGTH -1*.

```
Remote: SENS:CDP:IQL 2...63
```

SET COUNT / SET TO ANALYZE

This function offers the possibility for the R&S FSQ to capture up to 11970 slots (correspond to 8 seconds) with a *SINGLE SWEEP* and then post process all the data with *SET TO ANALYZE*.

If the *SET COUNT* is set to 1 (default value), the device behaves as before and with the *CAPTURE LENGTH* the number of PCG can be set.

For R&S FSQ the *SET COUNT* can be adjusted in the range of 1...190. Is the *SET COUNT* greater than 1 the *CAPTURE LENGTH* will be implicitly set to 63 slots and become unavailable. The *SET COUNT* defines then how many SETS of 63 slots shall be captured consecutively into the IQ RAM of the R&S FSQ. With the *SET TO ANALYZE* softkey the set for which the results are calculated can be defined. The range is from 0... (*SET COUNT-1*).

```
Remote: SENS:CDP:SET:COUN 1..190 (FSQ)
        SENS:CDP:SET:VAL <numeric_value>
```

SELECT CHANNEL

You can use the *SELECT CHANNEL* softkey to select a channel. All evaluations that consider results for a channel specify the results for the newly selected channel: *POWER VS SLOT*, *POWER VS SYMBOL*, *RESULT SUMMARY*, *BIT STREAM*, *SYMBOL CONST* and *SYMBOL EVM*.

In the evaluations *CODE DOM POWER*, *CODE DOM ERROR* and *CHANNEL TABLE* (all on screen A), the selected channel is marked red.

Entry of a channel is decimal in the form <Channel number>.<Spreading factor> with a decimal point as the demarcator. Instead of a channel number, you can enter a code number without any decimal point and spreading factor. This is referred to the spreading factor 16.

If the current channel table contains a concentrated channel to which the selected channel belongs, this concentrated channel is displayed with the associated channel number and spreading factor in the function field and marked red in the evaluations.

Example 1:

Entry of channel 5.8

Channel 3.4 is active in the channel table and also includes channels 5.8 and 6.8.

Channel 3.4 is shown in the entry box and marked red on screen A.

Example 2:

Entry of code number 9

Channel 3.4 is active in the channel table and includes code numbers 9, 10, 11 and 12.

Channel 3.4 is shown in the entry box and marked red on screen A.

The rotating wheel action depends on the evaluation on screen A and is geared to the graphic display. The rotating wheel always selects the adjacent channel. In the channel table, the rotating wheel is used to scroll through the list.

Remote: SENS:CDP:CODE 1...16

SELECT SLOT

The *SELECT SLOT* softkey serves for selecting a slot. Entry of the slot is decimal.

Here the range is from 0 to (IQ capture length - 1) (see *CAPTURE LENGTH* softkey).

All evaluations that consider results for a slot specify the results for the newly selected slot: *CODE DOM POWER*, *CODE DOM ERROR*, *CHANNEL TABLE*, *POWER VS SYMBOL*, *RESULT SUMMARY*, *BIT STREAM*, *SYMBOL CONST* and *SYMBOL EVM*.

In the evaluations *POWER VS SLOT*, *COMPOSITE EVM* and *PK CODE DOM ERR* the selected slot is marked red.

Remote: SENS:CDP:SLOT 0 ... (IQ_CAPTURE_LENGTH-1)

ADJUST REF LVL

The *ADJUST REF LVL* softkey matches the reference level of the analyzer to the measured channel power. This ensures that the RF attenuation and reference level settings are optimally matched to the signal level without the analyzer being overloaded or the dynamic response limited by too low a signal/noise ratio.

Remote: SENS:POW:ACH:PRES:RLEV

6.9.1 Configuration of measurements

The *CHAN CONF* hotkey opens a submenu with configuration options for the channel search. In this submenu you can select predefined channel tables that are then taken as a basis for measurements by the code domain analyzer.

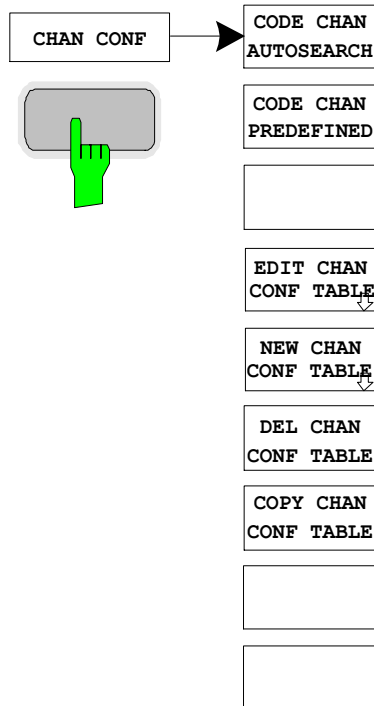

When you first press the hotkey, a table opens with the channel tables stored on the harddisk of the instrument. The table is merely an overview; to select one of the tables for a measurement, you must first press the *CODE CHAN PREDEFINED* softkey. The *RECENT* entry is the channel table of the last code domain power analysis that was performed.

```
Remote: CONF:CDP:BTS:CTAB:CAT?
```

CODE CHAN AUTOSEARCH

The *CODE CHAN AUTOSEARCH* softkey supports measurements of the code domain power analyzer in automatic search mode. This mode searches the whole code domain (all permissible symbol rates and channel numbers) for active channels. A channel is active when the minimum power you enter, referred to the total power, is exceeded (see *INACT CHAN THRESHOLD* softkey) and there is adequate signal/noise ratio.

CODE CHAN AUTOSEARCH is the default search mode with which CDP analysis starts. It is used primarily to give you an overview of the channels contained in the signal. If the signal contains channels that are not detected as active in automatic search mode, CDP analysis can be performed with predefined channel configurations by changing to *CODE CHAN PREDEFINED* mode.

```
Remote: CONF:CDP:BTS:CTAB:STAT OFF
```

CODE CHAN PREDEFINED

The *CODE CHAN PREDEFINED* softkey switches CDP analysis to the measuring mode with the help of predefined channel tables. In this mode there is no search for active channels in the code domain for the selected slot, instead the channels of a table defined prior to a measurement are assumed to be active.

When you press the softkey, a table opens with all channel tables stored on the instrument. CDP analysis is switched to predefined channel table mode. The last table of the automatic search mode is initially taken as a basis for the measurement. This table is available under *RECENT*.

You switch to one of the predefined channel tables by selecting the appropriate table entry and pressing one of the unit keys or Enter. From the next measurement onwards, the selected channel table is taken as a basis for evaluation for the selected slot. A tick marks the selected channel table.

```
Remote:  CONF:CDP:BTS:CTAB1:STAT ON
         CONF:CDP:BTS:CTAB:SEL "MY_FIRST_CH_TAB"
```

EDIT CHAN CONF TABLE

The *EDIT CHAN CONF TABLE* softkey opens the selected channel table, in which the channel configuration can be edited. In addition, a submenu opens with the softkeys required for editing the channel table.

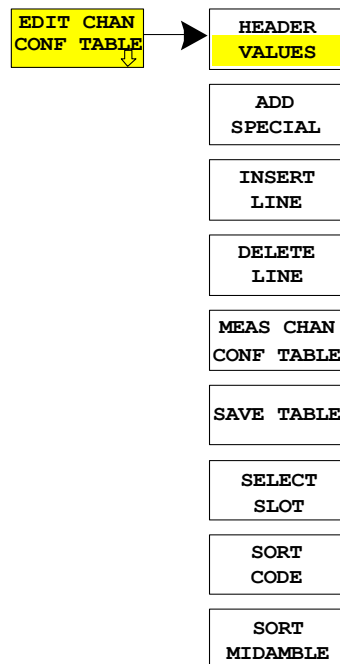

EDIT CHANNEL TABLE					
NAME:	My_First_Channel_Table			MA SHIFTS CELL	16
COMMENT:	Base Station Test 1				
TYPE	CHAN.SF	Modulation Type	Data Rate [kbps]	Midamble Shift	STATUS
MIDAMBLE	--	--	--	1	ACTIVE
PCCPCH	1.16	QPSK	17.6	--	ACTIVE
DPCH	2.16	QPSK	17.6	--	ACTIVE

Figure 34 Table for editing channel configuration

Basically any of the channel tables stored on the instrument can be edited as you wish. The edited table is not stored automatically on the harddisk of the instrument, first you must press the *SAVE TABLE* softkey. This avoids accidental overwriting of a table.

If a table is edited that is currently the basis for code domain power analysis, the edited table is used for the next measurement immediately after it is saved. So the effects of the changes in the table are immediately visible. Here again, the edited table is not saved on the harddisk of the instrument until you press the *SAVE TABLE* softkey.

If a table is edited that is stored on the harddisk of the instrument but not currently activated, the changes will not be visible until it has been saved (*SAVE TABLE* softkey) and then activated.

HEADER / VALUES

The *HEADER / VALUES* softkey sets the focus of the edit option either on the table entries or the table header.

Editing table header (*HEADER*):

This means editing values for the whole channel table. The following entries are available (confirm an entry with the help of the unit keys):

NAME: Name of the channel table. Overwriting of ready saved tables can be avoided by changing the name of a table. A table name must not consist of more than eight characters.

COMMENT: Comment on the channel table, e.g. description of slot allocation.

MA SHIFTS CELL:

Maximum number of usable midambles of the base station. In mode *CODE CHAN PREDEFINED* this entry replaces the value in the *SETTINGS* menu. (see softkey *SETTINGS, MA SHIFTS CELL*).

```
Remote: CONF:CDP:BTS:CTAB:NAME "NEW_TAB"
        CONF:CDP:BTS:CTAB:COMM "comment"
        CONF:CDP:BTS:CTAB:MSH <numeric>
```

Editing table entries (VALUES):

This means editing the actual data of the channel table. The following entries are available for each of the channels in the table (confirm an entry with the help of the unit keys):

TYPE: Channel type. Midamble or code channel can be selected. Special channels are identified by their names (P-CCPCH, S-CCPCH, FPACH, PDSCH, PICH). All other channels are entered as DPCH (dedicated physical channel) for normal data channels.

CHAN SF: The channel number and the spreading factor are entered for the channel in this column. For an entry without a decimal point the spreading factor is 16. Invalid entries are rejected.

MODULATION TYPE: Modulation type of the channel. You can choose between QPSK, 8PSK, 16QAM and 64 QAM.

DATA RATE: Data rate of the channel. This is a direct function of the spreading factor and modulation type of the channel, so it cannot be edited.

MIDAMBLE SHIFT: Here you can enter the midamble shift number for a midamble channel type. Possible entries are from 1 to the maximum number of midambles (see *SETTINGS*,

STATUS: The entry can be set active or inactive. Inactive entries are not used in measurements..

```
Remote: CONF:CDP:BTS:CTAB:DATA 2,4,1,1,1,1,0,0, 2,4,2,1,1,1,0,0
' Defines two data channels with QPSK modulation
```

ADD SPECIAL

The *ADD SPECIAL* softkey allows you to add special channels to the channel table.

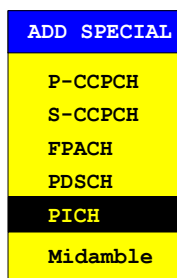

Figure 35 Table of special channels

All channels not listed are entered as DPCH by the *INSERT LINE* softkey. Stating special data channels only serves for the purpose of an overview in R&S FS-K76. Code domain measurements do not distinguish between special channels and data channels with the same parameters.

Remote: -- (integrated in command :CONF:CDP:BTS:CTAB:DATA)

INSERT LINE

The *INSERT LINE* softkey adds a new entry to the table. Entries can be made in any order. A channel is only included in CDP analysis if all required entries are present in the list.

Remote: --

DELETE LINE

The *DELETE LINE* softkey deletes the selected line from the table.

Remote: --

MEAS CHAN CONF TABLE

The *MEAS CHAN CONF TABLE* softkey starts a measurement in *CODE CHAN AUTOSEARCH* mode. The measurement results are adopted in the opened channel table.

Remote: --

SAVE TABLE

The *SAVE TABLE* softkey saves the table with its specified name.

CAUTION!

Editing channel models and saving them under the original name will result in the models being overwritten.

Remote: -- ((automatic with remote control))

SELECT SLOT

The *SELECT SLOT* softkey serves for selecting the slot on which the channel table is applied. At the same time this is the slot on which the slot-dependent evaluations are made.

Remote: --

SORT CODE

The *SORT CODE* softkey sorts the channel table in code order. First, all midambles are sorted in ascending order by their midamble shift. Then the code channels are

sorted in ascending order by their spreading factors and in ascending order by their code numbers within the same spreading factor.

Remote: --

SORT MIDAMBLE

The *SORT MIDAMBLE* softkey sorts the channel table in midamble order. The codes are listed after each midamble.

Remote: --

DEL CHAN CONF TABLE

The *DEL CHAN CONF TABLE* softkey deletes the selected table. The currently active table in *CODE CHAN PREDEFINED* mode cannot be deleted.

Remote: CONF:CDP:BTS:CTAB:DEL

COPY CHAN CONF TABLE

The *COPY CHAN CONF TABLE* softkey copies the selected table. The system asks the name under which you want to save the copy.

Remote: CONF:CDP:BTS:CTAB:COPY "CTAB2"

MAX MOD

The *MAX MOD* setting defines the highest modulation to be considered in the automatic channel search. In low SNR environments it may be necessary to limit the channel search to lower modulations than 64QAM.

Remote: SENS:CDP:MMA X QPSK | PSK8 | QAM16 | QAM64

NEW CHAN CONF TABLE

The *NEW CHAN CONF TABLE* softkey opens a submenu that is identical to the one for the *EDIT CHAN CONF TABLE* softkey. Unlike with *EDIT CHAN CONF TABLE*, a blank table is presented:

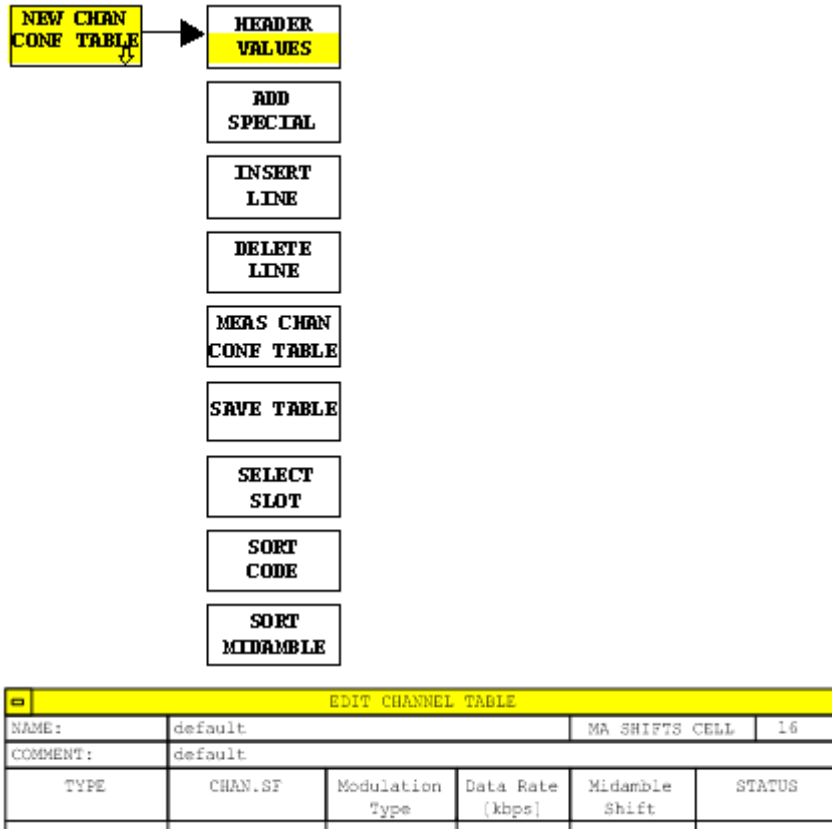
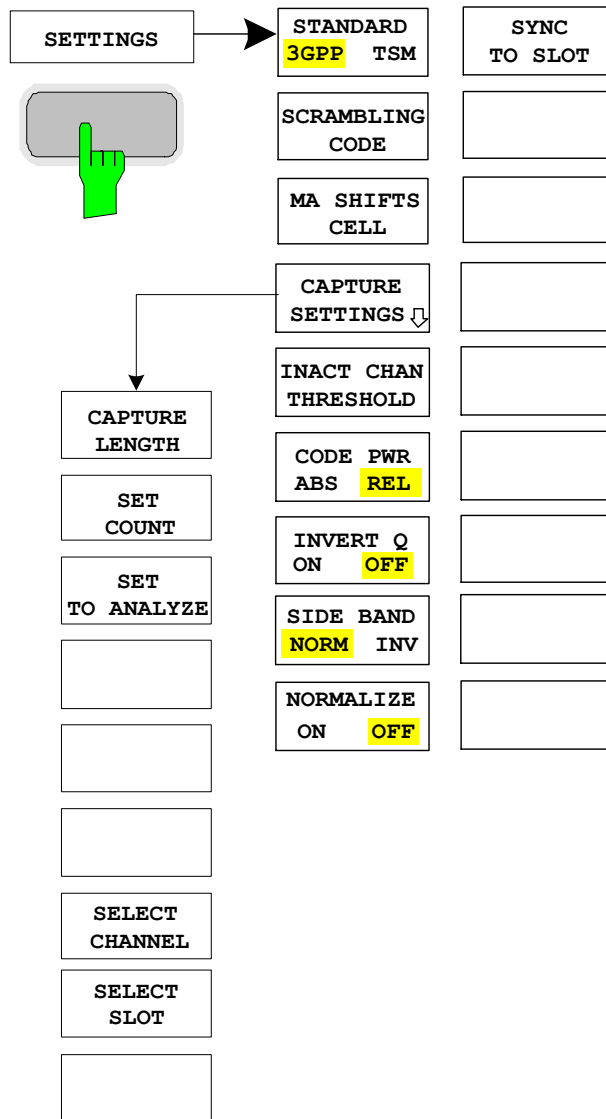

Figure 36 Creating new channel configuration

6.10 Configuration of application firmware - SETTINGS

The *SETTINGS* hotkey opens a submenu for setting the measurement parameters of the application firmware.



STANDARD 3GPP / TSM

The *STANDARD* softkey selects, whether the measurements are based on the 3GPP standard or the TSM standard. At the moment, this affects the spectrum emission mask measurement only.

Remote: SENS:CDP:STAN GPP | TSM

SCRAMBLING CODE

The *SCRAMBLING CODE* softkey allows entry of the scrambling code of the base station. Entry of the scrambling code is decimal.

Remote: SENS:CDP:SCOD 0...127

MA SHIFTS CELL

The *MA SHIFTS CELL* softkey allows entry of the maximum number of usable midamble shifts of the base station. In the mode *CODE CHAN PREDEFINED* this value will be replaced by the entry in the channel table.

Remote: SENS:CDP:MSH 2...16

CAPTURE SETTINGS

The *CAPTURE SETTINGS* softkey opens a submenu to define the capture configuration and the selection of slot and channel for the evaluation.

CAPTURE LENGTH

The *CAPTURE LENGTH* softkey allows entry of the number of slots to be captured. The range is from 2 to 63. For all evaluations with one value per slot on the X axis, the maximum value on the X axis is the set *CAPTURE LENGTH -1*.

Remote: SENS:CDP:IQL 2...63

SET TO ANALYZE / SET COUNT

This function offers the possibility for the **R&S FSQ** to capture up to 11970 slots (correspond to 8 seconds) with a *SINGLE SWEEP* and then post process all the data with *SET TO ANALYZE*.

If the *SET COUNT* is set to 1 (default value), the device behaves as before and with the *CAPTURE LENGTH* the number of PCG can be set.

For R&S FSQ the *SET COUNT* can be adjusted in the range of 1...190. Is the *SET COUNT* greater than 1 the *CAPTURE LENGTH* will be implicitly set to 63 slots and become unavailable. The *SET COUNT* defines then how many SETS of 63 slots shall be captured consecutively into the IQ RAM of the R&S FSQ. With the *SET TO ANALYZE* softkey the set for which the results are calculated can be defined. The range is from 0... (*SET COUNT*-1).

Remote: SENS:CDP:SET:COUN 1..190 (FSQ)
SENS:CDP:SET:VAL <numeric_value>

SELECT CHANNEL

You can use the *SELECT CHANNEL* softkey to select a channel. All evaluations that consider results for a channel specify the results for the newly selected channel: *POWER VS SLOT*, *POWER VS SYMBOL*, *RESULT SUMMARY*, *BIT STREAM*, *SYMBOL CONST* and *SYMBOL EVM*.

In the evaluations *CODE DOM POWER*, *CODE DOM ERROR* and *CHANNEL TABLE* (all on screen A), the selected channel is marked red.

Entry of a channel is decimal in the form <Channel number>.<Spreading factor> with a decimal point as the demarcator. Instead of a channel number, you can enter a code number without any decimal point and spreading factor. This is referred to the spreading factor 16.

If the current channel table contains a concentrated channel to which the selected channel belongs, this concentrated channel is displayed with the associated channel number and spreading factor in the function field and marked red in the evaluations.

Example 1:

Entry of channel 5.8

Channel 3.4 is active in the channel table and also includes channels 5.8 and 6.8.

Channel 3.4 is shown in the entry box and marked red on screen A.

Example 2:

Entry of code number 9

Channel 3.4 is active in the channel table and includes code numbers 9, 10, 11 and 12.

Channel 3.4 is shown in the entry box and marked red on screen A.

The rotating wheel action depends on the evaluation on screen A and is geared to the graphic display. The rotating wheel always selects the adjacent channel. In the channel table, the rotating wheel is used to scroll through the list.

Remote: SENS:CDP:CODE 1...16

SELECT SLOT

The *SELECT SLOT* softkey serves for selecting a slot. Entry of the slot is decimal. Here the range is from 0 to (IQ capture length - 1) (see *CAPTURE LENGTH* softkey). All evaluations that consider results for a slot specify the results for the newly selected slot: *CODE DOM POWER*, *CODE DOM ERROR*, *CHANNEL TABLE*, *POWER VS SYMBOL*, *RESULT SUMMARY*, *BIT STREAM*, *SYMBOL CONST* and *SYMBOL EVM*.

In the evaluations *POWER VS SLOT*, *COMPOSITE EVM* and *PK CODE DOM ERR* the selected slot is marked red.

Remote: SENS:CDP:SLOT 0 ... (IQ_CAPTURE_LENGTH-1)

INACT CHAN THRESHOLD

The *INACT CHAN THRESHOLD* softkey allows entry of the minimum relative power that a single channel must have compared to the total signal in order to be regarded as an active channel.

Channels below the specified threshold are regarded as inactive.

The two measurements *COMPOSITE EVM* and *PK CODE DOM ERR*, which are specified as measurements on the total signal, are performed using the list of active channels. Corruption of these two measurements always occurs when active channels are not detected as active and unoccupied channels are wrongly given the status of occupied. *INACT CHAN TRHESHOLD* can therefore be used to influence the results of the two measurements.

The default is -40 dB. If not all channels contained in the signal are detected automatically, *INACT CHAN THRESHOLD* must be decremented. If non-existent channels are detected, *INACT CHAN THRESHOLD* must be incremented.

```
Remote: SENS:CDP:ICTR -100 dB ... 0 dB
```

CODE PWR ABS / REL

The *CODE PWR ABS / REL* softkey selects for *CODE DOM POWER* and *POWER VS SLOT* evaluation whether the Y values should be displayed absolute (dBm) or relative (dB). Relative is referred to the mean total power of the data fields of the selected slot.

```
Remote:  CALC1:FEED "XPOW:CDP:RAT" (relative)
          CALC1:FEED "XPOW:CDP" (absolute)
          CALC1:FEED "XTIM:CDP:PVSL:RAT" (relative)
          CALC1:FEED "XTIM:CDP:PVSL:ABS" (absolute)
```

INVERT Q ON / OFF

The *INVERT Q ON / OFF* softkey inverts the sign of the Q component of the signal. The default setting is *OFF*.

```
Remote: SENS:CDP:QINV OFF
```

SIDEBAND NORM / INV

The *SIDEBAND NORM / INV* softkey chooses between measurement of the signal in a normal and an inverted spectrum.

NORM This allows measurement of base station RF signals.

INV This is practical for measurements on IF modules or components in the case of spectral inversion.

The default setting is *NORM*.

```
Remote: SENS:CDP:SBAN NORM|INV
```

NORMALIZE ON / OFF

The *NORMALIZE ON / OFF* softkey eliminates the DC offset from the signal. The default setting is *OFF*.

```
Remote: SENS:CDP:NORM OFF
```

SYNC TO SLOT

The softkey *SYNC TO SLOT* changes the phase reference from DwPCH (OFF) to the midamble of the selected slot (ON).

By default the R&S FS-K76 determines the phase reference for all downlink data slots from the downlink pilot channel (DwPCH). For e.g. beamforming or repeater measurements it might be necessary to apply different phase offsets to each time slot. Using the DwPCH as phase reference leads to rotated constellation diagrams and bad EVM values in these time slots.

By activating the new setting 'SYNC TO SLOT' the R&S FS-K76 determines the phase reference from the midamble of the selected slot. Thus the data slots can be phase rotated to each other without degrading the EVM results. The selected slot must contain at least one data channel with sufficient power for successful synchronization.

Remote: SENS:CDP:STSL ON | OFF

SYNC TO CODE / MA

This softkey selects the slot synchronization mode. It is effective only if SYNC TO SLOT is activated.

If CODE is selected, the phase reference is determined by a multi-stage algorithm involving code channels and midambles. At least one code channel within the selected slot must be QPSK or 8PSK modulated.

If MA is selected, the phase reference is determined by the midamble area of the selected slot. Hence there is no requirement about the code channel modulation.

Remote: SENS:CDP:STSL:MODE CODE | MA

ROTATE CODE TO MA

By default the R&S FS-K76 determines one phase reference for all midambles and code channels of a data slot. If ROTATE CODE TO MA is selected, phase rotations between the code channels are allowed. Each code channel gets its own phase reference from the associated midamble according to section AA.2 of the standard document 3GPP TS 25.221. If the associated midamble is missing, the common phase reference is used for this code channel.

Remote: SENS:CDP:STSL:ROT ON | OFF

6.11 Frequency setting – *FREQ* key

The *FREQ* key opens a submenu for changing the measurement frequency.

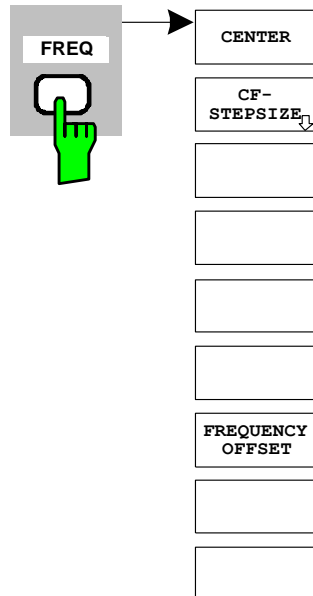

CENTER

The *CENTER* softkey opens the input window for manual entry of the center frequency.

The permissible input range of the center frequency is

$$\text{Minspan}/2 \leq f_{\text{center}} \leq f_{\text{max}} - \text{Minspan}/2$$

f_{center} center frequency

Minspan smallest selectable span > 0 Hz (10 Hz)

f_{max} maximum frequency

Remote: FREQ:CENT 100MHz

CF STEPSIZE

CF STEPSIZE opens a submenu for setting incrementation of the center frequency.

There is an option of entering the step size manually (*MANUAL* softkey) or using the current measurement frequency (*CENTER* softkey). The softkeys are described in the manual for the basic unit.

Remote: FREQ:CENT:STEP <numeric_value>

FREQUENCY OFFSET

The *FREQUENCY OFFSET* softkey enables entry of an arithmetic frequency offset that is added to the frequency axis labelling. The range for the offset is -100 GHz to 100 GHz. The default setting is 0 Hz.

Remote: `FREQ:OFFS 10 MHz`

6.12 Span settings – *SPAN* key

The *SPAN* key is disabled for measurements in the code domain analyzer. For all other measurements (see *MEAS* key), the permissible span settings are explained for the measurement concerned. The associated menu corresponds to that of the measurement in the basic unit and is described in the manual for the basic unit.

6.13 Level settings - *AMPT* key

The *AMPT* key opens a submenu for setting the reference level.

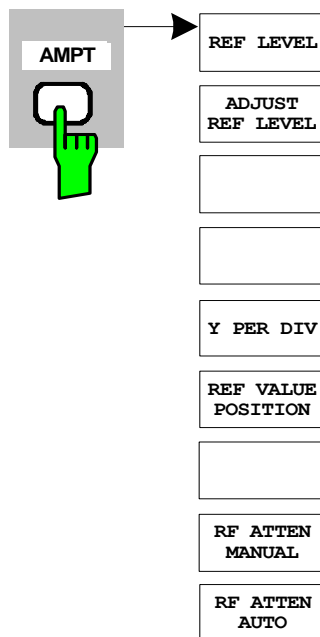

REF LEVEL

The *REF LEVEL* softkey enables entry of the reference level. The entry is in dBm.

Remote: `DISP:WIND:TRAC:Y:RLEV -60dBm`

ADJUST REF LEVEL

ADJUST REF LEVEL executes a routine for optimum matching of the reference level to the signal.

Remote: SENS1:CDP:LEV:ADJ

Y PER DIV

Y PER DIV sets the grid spacing on the Y axis for all diagrams in which this is possible.

Remote: DISP:WIND2:TRACe1:Y:SC:PDIV

REF VALUE POSITION

REF VALUE POSITION allows entry of the position of the Y axis reference value on the axis (0 to 100%).

Remote: DISP:WIND1:TRAC1:Y:SCAL:RPOS

RF ATTEN MANUAL

The *RF ATTEN MANUAL* softkey activates entry of attenuation independently of reference level.

The attenuation can be altered in 10 dB increments from 0 to 70 entries are rounded to the next lowest integral. If the specified reference level can no longer be set for the given RF attenuation, it is matched and the "Limit reached" message appears.

Remote: INP:ATT 40 DB

RF ATTEN AUTO

The *RF ATTEN AUTO* softkey sets the RF attenuation automatically as a function of the set reference level.

This ensures that the optimum attenuation you wish is always used.

RF ATTEN AUTO is the default setting.

Remote: INP:ATT:AUTO ON

6.14 Marker settings - MKR key

The *MARKER* key opens a submenu for the marker settings.

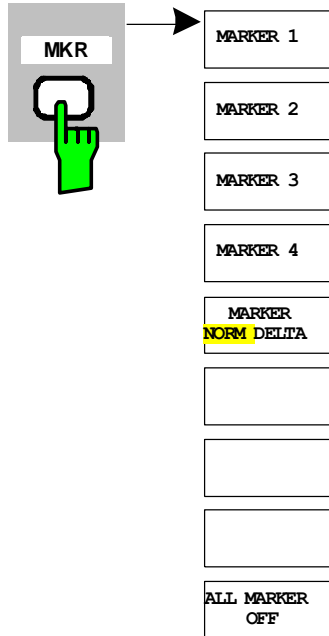

Markers are not available for *RESULT SUMMARY* and *CHANNEL TABLE* evaluations. Up to four markers can be activated in all other evaluations and defined as markers or delta markers with the *MARKER NORM / DELTA* softkey.

The *MARKER 1-4* softkeys select and enable the particular marker.

MARKER 1 is always the normal marker after it is enabled, while *MARKER 2* through *4* are delta markers referred to *MARKER 1* after they are enabled. The *MARKER NORM / DELTA* softkey can be used to transform these markers into markers with absolute measured value indication. If *MARKER 1* is the active marker, *MARKER NORM / DELTA* is used to enable an additional delta marker.

Press the *MARKER 1-4* softkeys again to disable the selected marker.

```
Remote:  CALC:MARK ON;
         CALC:MARK:X <value>;
         CALC:MARK:Y?
         CALC:DELT ON;
         CALC:DELT:MODE ABS|REL
         CALC:DELT:X <value>;
         CALC:DELT:X:REL?
         CALC:DELT:Y?
```

ALL MARKER OFF

The *ALL MARKER OFF* softkey disables all markers (reference and delta markers). It also disables the functions and displays associated with the markers and delta markers.

```
Remote:  CALC:MARK:AOFF
```

The parameters relating to an enabled marker are read out above the diagrams:

Marker 1 [T1]	-5.00 dB
DR 70.4kbps Chan 1.4 Code 3	

Figure 37 Marker field of CDP measurement

For all other measurements not belonging to the code domain analyzer the marker functions of the basic unit apply..

6.15 Marker settings - *MKR*→ key

The *MKR*→ key opens a submenu for marker functions:

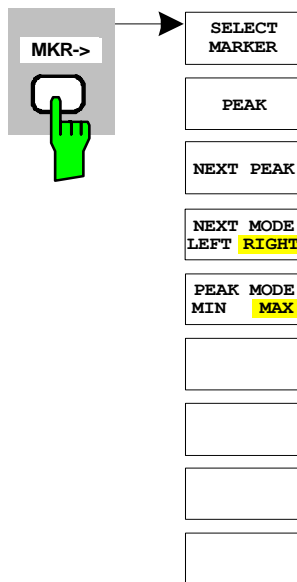

SELECT MARKER

The *SELECT MARKER* softkey selects the required marker in a data entry box. If the marker is disabled, it is enabled and can then be moved. The entry is numeric. Delta marker 1 is selected by entering '0'.

```
Remote:  CALC:MARK1 ON;
          CALC:MARK1:X <value>;
          CALC:MARK1:Y?
```

PEAK

The *PEAK* softkey sets the active marker or delta marker to the maximum/minimum of the associated trace.

If no marker was activated before opening the *MKR*-> menu, marker 1 is automatically enabled and the *PEAK* function is executed.

```
Remote:  CALC:MARK:MAX
         CALC:DELT:MAX
         CALC:MARK:MIN
         CALC:DELT:MAX
```

NEXT PEAK

The *NEXT PEAK* softkey sets the active marker or delta marker to the next lowest maximum/minimum value of the associated trace. The search direction is specified by the setting in the *NEXT MODE LEFT / RIGHT* submenu.

```
Remote:  CALC:MARK:MAX:NEXT
         CALC:DELT:MAX:NEXT
         CALC:MARK:MIN:NEXT
         CALC:DELT:MIN:NEXT
```

NEXT MODE LEFT / RIGHT

The *NEXT MODE LEFT / RIGHT* softkey sets the direction for searching for the next maximum/minimum value. *SEARCH NEXT LEFT / RIGHT* searches for the next signal maximum left/right from the active marker, i.e. only signal segments smaller/greater than the current marker position enter the search.

```
Remote:  CALC:MARK:MAX:LEFT
         CALC:DELT:MAX:LEFT
         CALC:MARK:MIN:LEFT
         CALC:DELT:MIN:LEFT
         CALC:MARK:MAX:RIGHT
         CALC:DELT:MAX:RIGHT
         CALC:MARK:MIN:RIGHT
         CALC:DELT:MIN:RIGHT
```

PEAK MODE MIN / MAX

The *PEAK MODE MIN / MAX* softkey sets whether the peak search should determine the maximum or minimum value of the trace. The parameter affects the response of the *PEAK* and *NEXT PEAK* softkeys.

```
Remote:  --
```

6.16 Marker functions - *MKR FCTN* key

The *MKR FCTN* key is disabled for all measurements of the code domain analyzer. The softkeys of the menu are described in the manual of the basic unit for all other measurements of the R&S FS-K76.

6.17 Bandwidth setting - *BW* key

The *BW* key is disabled for all measurements of the code domain analyzer. The softkeys associated with the menu are described in the manual of the basic unit for all other measurements of the R&S FS-K76.

6.18 Measurement control - *SWEEP* key

The menu of the *SWEEP* key contains options for switching between one-shot and continuous measurement and for the control of one-shot measurements. For measurements in the spectral range, the measurement time for a sweep can also be set. All softkeys associated with the menu are described in the manual of the basic unit.

6.19 Measurement selection - *MEAS* key

The menu of the *MEAS* key contains all the measurements that can be selected at the pressing of a key in the R&S FS-K76. The menu and its submenus are described in Chapter 6.

6.20 Trigger functions - *TRIG* key

The selectable trigger options depend on the measurement selected. The code domain power analyzer can work in free running mode or use an external trigger. The trigger options for all other measurements are identical to those of the corresponding measurement in the basic unit. The associated softkeys are described in the manual for the basic unit.

EXTERN

With the softkey *EXTERN* the external trigger source can be selected. From firmware V2.60/3.60 on also the external trigger level can be adjusted in the range from 0.5V to 3.5V. The default value is 1.4V.

```
Remote: TRIG:SEQ:LEV:EXT <numeric_value>
```

6.21 Trace settings - *TRACE* key

The *TRACE* key opens the following submenu:

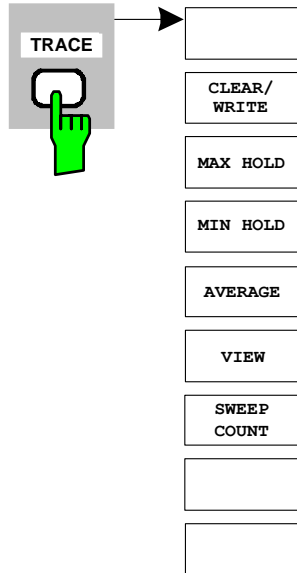

CLEAR / WRITE

The *CLEAR / WRITE* softkey activates overwrite mode for the acquired measured values, i.e. the trace is rewritten for each sweep.

After every actuation of the *CLEAR / WRITE* softkey, the unit deletes the selected trace memory and restarts the measurement.

Remote: `DISP:WIND:TRAC:MODE WRIT`

MAX HOLD

The *MAX HOLD* softkey activates the peak value detector.

On every sweep, the analyzer only accepts the new measured value into the saved trace data if it is larger than the previous one.

Pressing the *MAX HOLD* softkey a second time deletes the trace memory and starts peak value detection from the beginning again.

Remote: `DISP:WIND:TRAC:MODE MAXH`

MIN HOLD

The *MIN HOLD* softkey activates the minimum value detector.

On every sweep, the analyzer only accepts the new measured value into the saved trace data if it is smaller than the previous one.

Pressing the *MIN HOLD* softkey a second time deletes the trace memory and starts minimum peak detection from the beginning again..

Remote: `DISP:WIND:TRAC:MODE MINH`

AVERAGE

The *AVERAGE* softkey enables the trace averaging function. The average is formed over several sweeps. Averaging is performed as a function of the *AVG MODE LOG / LIN* setting on the logarithmized level values or the measured power/voltage values.

Averaging is restarted every time the *AVERAGE* softkey is pressed. The trace memory is always cleared.

```
Remote: DISP:WIND:TRAC:MODE AVER
```

For measurements in the code domain analyzer, an *AVERAGE*, *MAX HOLD* or *MIN HOLD* is possible.

In channel occupancy table evaluation, the channel configuration measured on the first sweep is kept for the trace statistics.

If the signal is reconfigured, you must again press the *SINGLE SWEEP* softkey (and possibly *CONTINUOUS SWEEP*).

The evaluations *RESULT SUMMARY*, *BIT STREAM* and the *CONSTELLATION* diagrams only support *CLEAR / WRITE* mode.

VIEW

The softkey *VIEW* freezes the trace.

```
Remote: DISP:WIND:TRAC:MODE VIEW
```

SWEEP COUNT

The *SWEEP COUNT* softkey sets the number of sweeps used for averaging. The permissible range is 0 to 30000, though the following should be noted:

Sweep count = 0 means sliding averaging with averaging length of 10.

Sweep count = 1 means no averaging.

Sweep count > 1 means averaging over the specified number of sweeps; in a continuous sweep the averaging changes to sliding averaging once this number has been reached.

The default is sliding averaging (sweep count = 0). The number of sweeps used for averaging is always equal to the averaging length of 10 for all active traces in the selected diagram.

```
Remote: SWE:COUN 64
```

6.22 Display-Lines - Taste *LINES*

The *LINES* key is disabled for all measurements of the code domain analyzer. The menu setting options for all other measurements are equivalent to those of the corresponding measurement in the basic unit. The respective softkeys are described in the manual for the basic unit.

6.23 Measurement screen settings - *DISP* key

The menu of the *DISP* key contains softkeys for configuring the measurement screen. The menus and softkey features are described in the manual of the basic unit.

6.24 Storing and loading unit data - *FILE* key

The *FILE* menu is the same as that of the basic unit. All softkeys are described in the manual for the basic unit.

All keys on the front panel of the unit that are not specifically mentioned are identical to those of the basic unit. The functions of the keys and the softkeys are described in the manual of the basic unit.

6.25 Preset of device - *PRESET* key

The *PRESET* key presets the device. The behaviour is the same as of the basic unit and is described in the manual for the basic unit.

6.26 Calibration of device - *CAL* key

The menu *CAL* is the same as that of the basic unit. All softkeys are described in the manual for the basic unit.

6.27 Setup of device - *SETUP* key

The menu *SETUP* is the same as that of the basic unit. All softkeys are described in the manual for the basic unit. The usage of transducer factors is possible in the Code-Domain as well as in the RF measurements.

Using the FS-K9 "Measurements with Power Sensor" is also possible within that application. Therefore the FS-K9 must be installed and the option key must be entered, then in the side menu the softkey *POWERMETER* is available. For further details of the FS-K9 please refer to the FS-K9 software manual.

6.28 Printing - *HCOPY* key

The menu *HCOPY* is the same as that of the basic unit. All softkeys are described in the manual for the basic unit.

All keys on the front panel of the unit that are not specifically mentioned are identical to those of the basic unit. The functions of the keys and the softkeys are described in the manual of the basic unit.

7 Remote Control Commands

This chapter describes the remote control commands for the application firmware.

The commands that also apply to the basic unit in *SPECTRUM* mode and the system settings are described in the operating manual for the analyzer.

7.1 CALCulate:FEED subsystem

CALCulate:FEED subsystem selects the type of evaluation for the measured data. This corresponds to the selection of the result display in manual operation.

CALCulate<1|2>:FEED <string>

This command selects the measured data that are displayed.

Parameters

```
<string> ::= 'XPOW:CDP' |
             'XPOW:CDP:RAT' |
             'XPOW:CDEP' |
             'XTIM:CDP:MACCuracy' |
             'XTIM:CDP:PVSLOT:ABS' |
             'XTIM:CDP:PVSLOT:RAT' |
             'XTIM:CDP:PVSymbol' |
             'XTIM:CDP:BSTream' |
             'XTIM:CDP:ERR:SUMM' |
             'XTIM:CDP:ERR:CTABLE' |
             'XTIM:CDP:ERR:PCDomain' |
             'XTIM:CDP:SYMB:CONST' |
             'XTIM:CDP:SYMB:EVM' |
             'XTIM:CDP:COMP:EVM' |
             'XTIM:CDP:COMP:CONST'
```

The meanings of the string parameters are as follows:

'XPOW:CDP'	Result display of code domain power (absolute) in bar graph (CALCulate<1>)
'XPOW:CDP:RAT'	Result display of code domain power ratio (relative) in bar graph (CALCulate<1>)
'XPOW:CDEP'	Result display of code domain error power in bar graph (CALCulate<1>)
'XTIM:CDP:ERR:SUMM'	Tabular display of results (CALCulate<2>)
'XTIM:CDP:ERR:CTABLE'	Display of channel occupancy table (CALCulate<1>)
'XTIM:CDP:ERR:PCDomain'	Result display of peak code domain error (CALCulate<2>)
'XTIM:CDP:MACCuracy'	Result display of composite EVM (CALCulate<2>)
'XTIM:CDP:PVSLOT:ABS'	Result display of power versus slot, absolute (CALCulate<2>)

'XTIM:CDP:PVSLOT:RAT'	Result display of power versus slot, relative (CALCulate<2>)
'XTIM:CDP:PVSymbol'	Result display of power versus symbol (CALCulate<2>)
'XTIM:CDP:BSTream'	Result display of bit stream (CALCulate<2>)
'XTIM:CDP:SYMB:CONST'	Result display of symbol constellation (CALCulate<2>)
'XTIM:CDP:SYMB:EVM'	Result display of error vector magnitude (CALCulate<2>)
'XTIM:CDP:COMP:CONST'	Result display of composite constellation (CALCulate<2>)

Example:

```

INST:SEL BTDS
'Activate TD-SCDMA BTS

INIT:CONT OFF
'Select single sweep

CALC2:FEED 'XTIM:CDP:MACC '
'Select COMP EVM evaluation

INIT;*WAI
'Start measurement with synchronization

TRAC? TRACE2
'Poll COMP EVM data

```

Characteristics:

*RST value: 'XPOW:CDP:RAT' (CALCulate<1>)
'XTIM:CDP:ERR:SUMM' (CALCulate<2>)

SCPI: compliant

Note:

Code domain power measurements are always shown in split screen mode and the allocation of the evaluation to the measurement window is fixed. The necessary or allowed numerical suffix in CALCulate is therefore specified in brackets in every evaluation.

7.2 CALCulate:LIMit: ESpectrum subsystem

CALCulate:LIMit: ESpectrum subsystem defines the limit check for spectral measurements.

CALCulate:LIMit:ESpectrum:CHECK:X?**CALCulate:LIMit:ESpectrum:CHECK:Y?**

These commands return the X-value and the Y-value respectively at the maximum overstepping of the spectrum emission mask limits.

Example:

```
INST BTDS
'Switches unit to TD-SCDMA BTS mode

CALC:LIM:ESP:CHEC:X?
'Returns the frequency at the maximum overstepping
```

Characteristics:

*RST value: —
 SCPI: instrument-specific

CALCulate:LIMit:ESPectrum:MODE AUTO | MANual | USER

This command enables and disables automatic selection of the limit line in the spectrum emission mask measurement.

Parameters

AUTO The limit line sets itself according to the measured channel power.

MANUAL One of the three specified limit lines is set. The selection is made with the command `CALC:LIM:ESP:VAL`.

USER Poll only, user-defined limit lines are enabled (refer to the details of limit lines in the manual for the unit).

Example:

```
INST:SEL BTDS
'Activate TD-SCDMA BTS

INIT:CONT OFF
'Select single sweep

CONF:CDP:MEAS ESP
'Select spectrum emission mask measurement

CALC:LIM:ESP:MODE AUTO
'Activates automatic selection of limit line

INIT;*WAI
'Start measurement with synchronization

CALC:LIM:FAIL?
'Poll result of limit check
```

Characteristics:

*RST value: AUTO
 SCPI: instrument-specific

CALCulate:LIMit:ESpectrum:REStore

This command restores the standard limit lines for spectrum emission mask measurement. All changes to the standard limit lines are thus lost and they are again as when delivered.

Example:

```
INST BTDS
'Switches unit to TD-SCDMA BTS mode

CALC:LIM:ESP:REST
'Resets spectrum emission mask limit lines to default
```

Characteristics:

*RST value: -
SCPI: instrument-specific

This command is an event, so it has neither a poll nor an *RST value.

CALCulate:LIMit:ESALuePectrum:VALue <numeric_value>

This command switches to manual limit line selection. The limit line is selected by specifying the expected power as a value. One of the three possible limit lines is selected depending on the value entered:

Entered value in dBm	Selected limit line	Value when polled
Value \geq 34	$P \geq 34$	34
$26 \leq$ Value $<$ 34	$26 \leq P < 34$	26
Value $<$ 26	$P < 26$	0

Example:

```
INST:SEL BTDS
'Activate TD-SCDMA BTS

INIT:CONT OFF
'Select single sweep

CONF:CDP:MEAS ESP
'Select spectrum emission mask measurement

CALC:LIM:ESP:VAL 34
'Activates manual selection of limit line and selects one for  $P \geq 34$ 

INIT;*WAI
'Start measurement with synchronization

CALC:LIM:FAIL?
'Poll result of limit check
```

Characteristics:

*RST value: 0
SCPI: instrument-specific

7.3 CALCulate:MARKer subsystem

**CALCulate<1|2>:MARKer<1>:FUNction:CDPower[:BTS]:RESult?
SLOT | PDATa | PD1 | PD2 | PMIDamble | RHO | MACCuracy | PCDerror | FERRor
| CERRor | TFRame | IQOFFset | IQIMbalance | ACTive | SRATe | CHANnel |
SFACtor | CDPabsolute | CDPRelative | EVMRms | EVMPeak | ARCDError**

This command polls the measured and calculated values of code domain power analysis. The results are provided for the channel to which the code selected by the `CDPower:CODE` command belongs.

Parameters:

Global results of selected slot:

SLOT	Slot number
PDATa	Power data fields in dBm
FERRor	Frequency error in Hz
PD1	Power data field 1 in dBm
CERRor	Chip rate error in ppm
PD2	Power data field 2 in dBm
TFRame	Trigger to frame
PMIDamble	Power midamble in dBm
IQIMbalance	IQ imbalance in %
RHO	RHO
IQOFFset	IQ offset in %
MACCuracy	Composite EVM in %
ACTive	Number of active channels
PCDerror	Peak code domain error in dB
ARCDError	Average RCDE of active channels

Channel results:

SRATe	Data rate in kbps
CHANnel	Channel number
SFACtor	Spreading factor of channel
CDPRelative	Channel power relative in dB
CDPabsolute	Channel power absolute in dBm
EVMRms	Error vector magnitude RMS in %
EVMPeak	Error vector magnitude Peak in %

Note:

The trigger to frame (`TFRame`) value produces a 9 if the trigger is set to FREE RUN.

Example:

```
INST:SEL BTDS
'Activate TD-SCDMA BTS meaning CDP relative on screen A and Result
Summary active on screen B

INIT:CONT OFF 'Select single sweep

INIT;*WAI
'Start measurement with synchronization
```

```
CALC:MARK:FUNC:CDP:RES? PDAT
```

'Read out power of data fields

```
CDP:SLOT 5
```

'Selects slot 5

```
CDP:CODE 11
```

'Select code number 11

```
CALC:MARK:FUNC:CDP:RES? EVMR
```

'Read out EVM RMS of code with number 11 in slot 5

Characteristics:

*RST value: –

SCPI: instrument-specific

CALCulate<1|2>:MARKer<1...4>:FUNCtion:POWER:MODE WRITe | MAXHold

This command selects the Clear Write or Maxhold for Channel Power values.

Example:

```
CALC:MARK:FUNC:POW:MODE MAXH
```

'Maxhold for Channel Power value

Characteristics:

*RST value: WRITe

SCPI: instrument-specific

CALCulate<1|2>:MARKer<1 to 4>:FUNCtion:POWER:RESult? ACPower | AOBandwidth | AOBWidth | CPOWER | MCACpower | OBANdwidth | OBANdwidth

This command queries the result of the power measurement performed in the selected window. If necessary, the measurement is switched on prior to the query.

The channel spacings and channel bandwidths are configured in the SENSE:POWER:ACHannel subsystem.

To obtain a valid result, a complete sweep with synchronization to the end of the sweep must be performed before a query is output. Synchronization is possible only in the single-sweep mode

Note:

The parameters AOBandwidth and AOBWidth are available only from firmware version 4.5x.

Parameter

ACPower: adjacent channel power measurement
Results are output in the following sequence, separated by commas:

1. Power of transmission channel
2. Power of lower adjacent channel
3. Power of upper adjacent channel
4. Power of lower alternate channel 1
5. Power of upper alternate channel 1

6. Power of lower alternate channel 2
7. Power of upper alternate channel 2

The number of measured values returned depends on the number of adjacent/alternate channels selected with

`SENSe:POWer:ACHannel:ACPairs`

With logarithmic scaling (`RANGE LOG`), the power is output in the currently selected level unit; with linear scaling (`RANGE LIN dB` or `LIN %`), the power is output in W. If `SENSe:POWe:ACH:MODE REL` is selected, the adjacent/alternate-channel power is output in dB.

`AOBandwidth`

`AOBWidth`

Measurement of occupied bandwidth, all results

The results include the left and right frequency/level information:

1. Occupied bandwidth in Hz
2. T1 marker position in Hz (left marker)
3. T1 marker level
4. T2 marker position in Hz (right marker)
5. T2 marker level

The Occupied Bandwidth is marker position T2 – T1.

`CPOWer:`

Channel power measurement

With logarithmic scaling (`RANGE LOG`), the channel power is output in the currently selected level unit; with linear scaling (`RANGE LIN dB` or `LIN %`), the channel power is output in W.

`MCACpower:`

Channel/adjacent channel power measurement with several carrier signals

Results are output in the following sequence, separated by commas.

1. Power of carrier signal 1
2. Power of carrier signal 2
3. Power of carrier signal 3
4. Power of carrier signal 4
5. Power of carrier signal 5
6. Power of carrier signal 6
7. Power of carrier signal 7
8. Power of carrier signal 8
9. Power of carrier signal 9
10. Power of carrier signal 10
11. Power of carrier signal 11
12. Power of carrier signal 12
13. Total power of all carrier signals
14. Power of lower adjacent channel
15. Power of upper adjacent channel
16. Power of lower alternate channel 1
17. Power of upper alternate channel 1
18. Power of lower alternate channel 2
19. Power of upper alternate channel 2

The number of measured values returned depends on the number of carrier signals and adjacent/alternate channels selected with

SENSe:POWer:ACHannel:TXChannel:COUNT and
SENSe:POWer:ACHannel:ACPairs

If only one carrier signal is measured, the total value of all carrier signals will not be output.

With logarithmic scaling (RANGE LOG), the power is output in dBm; with linear scaling (RANGE LIN dB or LIN %), the power is output in W. If SENSe:POWer:ACHannel:MODE REL is selected, the adjacent/alternate-channel power is output in dB.

OBANdwidth | OBWidth

Measurement of occupied bandwidth

The occupied bandwidth in Hz is returned

Characteristics:

*RST value: -

SCPI: instrument-specific

This command is a query and therefore has no *RST value

7.4 CALCulate:PEAKsearch | PSEarch subsystem

CALCulate<1|2>:PEAKsearch|PSEarch:AUTO ON | OFF

By using this command, the peak list in the spurious measurement is calculated automatically after a measurement. For each range, exactly one peak value is calculated.

The SENSe suffix is unused.

Example:

CALC:PEAK:AUTO ON

Switches the automatic peak search on

Characteristics:

*RST value: OFF

SCPI: instrument-specific

7.5 CONFigure:CDPower subsystem

This subsystem contains the commands for selecting and configuring measurements in the TD-SCDMA application firmware. Only the numeric suffix 1 is allowed for CONFigure. You will find further settings for code domain power analysis under the :[SENSe]:CDPower command. Further settings for spectrum emission mask measurement can be found under the CALCulate:LIMit:ESpectrum command.

CONFigure:CDPower[:BTS]:CTABLE:CATalog?

This command polls the names of all channel tables saved on harddisk for TD-SCDMA BTS.

The syntax of the output format is as follows:

```
<Sum of sizes of all subsequent files>,<Spare capacity on harddisk>,  
<1st file name>,<1st file size>,<2nd file name>,,<2nd file size>,,...,<nth file  
name>,,  
<nth file size>,,
```

Example:

```
INST:SEL BTDS  
'Activate TD-SCDMA BTS  
  
CONF:CDP:CTAB:CAT?  
'Poll catalog
```

Characteristics:

*RST value: -
SCPI: instrument-specific

CONFigure:CDPower[:BTS]:CTABLE:COMMent <string>

This command defines a comment on the selected channel table.

Before using this command, you must set the name of the channel table using the CONF:CDP:CTAB:NAME command and enter a valid channel table by CONF:CDP:CTAB:DATA.

Example:

```
INST:SEL BTDS  
'Activate TD-SCDMA BTS  
  
CONF:CDP:CTAB:NAME 'NEW_TAB'  
'Select table to edit  
  
CONF:CDP:CTAB:COMM  
'Comment for NEW_TAB'
```

Characteristics:

*RST value: -
SCPI: instrument-specific

CONFigure:CDPower[:BTS]:CTABLE:COPY <file_name>

This command copies one channel table to another. You select the channel table you want to copy by the `CONF:CDP:CTAB:NAME` command.

Parameters:

<file_name> ::= name of new channel table

Example:

```
INST:SEL BTDS
'Activate TD-SCDMA BTS

CONF:CDP:CTAB:NAME 'CTAB_1'
'Select table to edit

CONF:CDP:CTAB:COPY 'CTAB_2'
'Copies CTAB_1 to C_TAB2
```

Characteristics:

*RST value: —
SCPI: instrument-specific

The name of the channel table may consist of up to eight characters. This command is an event, so it has neither an *RST value nor a poll function.

CONFigure:CDPower[:BTS]:CTABLE:DATA 1..6, 0..4, 1..16, 0..2, 1..16, 0 | 1, 0, 0...4

This command defines a channel table. The whole table is defined in one operation. The inactive channels (INACTIVE) do not have to be defined. Eight values are specified for a line of a table.

< Channel type >, <Code class>, <Code number>, <Modulation type>, <Midamble shift>, <Status>, <Reserved 1>, <Reserved 2>,

Channel type: The channel type is coded with numbers as follows:
 1 = Midamble
 2 = DPCH
 3 = P-CCPCH
 4 = S-CCPCH
 5 = FPACH
 6 = PRACH

Code class: 0-4

Code number: 1-16

Modulation type: 0 = invalid (for midamble)
 1 = QPSK
 2 = 8PSK
 3 = 16QAM
 4 = 64QAM

Midamble shift: 1-16

Status: 0: inactive, 1: active
 Can be used in a setting command to disable a channel temporarily.

Reserved 1: Always 0, reserved for additions
 Reserved 2: Always 0, reserved for additions

Before using this command, you must set the name of the channel table using the `CONF:CDP:CTAB:NAME` command.

Example:

```
INST:SEL BTDS
'Activate TD-SCDMA BTS

CONF:CDP:CTAB:NAME 'NEW_TAB'
'Select table to edit

CONF:CDP:CTAB:DATA 2,4,1,1,1,1,0,0, 2,4,2,1,1,1,0,0
'Defines two data channels with QPSK modulation
```

Characteristics:

*RST value: –
 SCPI: instrument-specific

CONFigure:CDPower[:BTS]:CTABLE:DELeTe

This command deletes the selected channel table. You select the channel table you want to delete by the `CONF:CDP:CTAB:NAME` command.

Example:

```
INST:SEL BTDS
'Activate TD-SCDMA BTS

CONF:CDP:CTAB:NAME 'CTAB_2'
'Select table to edit

CONF:CDP:CTAB:DEL
'Deletes CTAB_2
```

Characteristics:

*RST value: —
 SCPI: instrument-specific

This command is an event, so it has neither an *RST value nor a poll function.

CONFigure<1>:CDPower[:BTS]:MEASurement POWER | ACLR | ESPectrum | OBANdwith | OBWidth | CDPower | CCDF

This command selects the measurement of the Application Firmware R&S FS-K76, TD-SCDMA base station test. The predefined settings of the different measurements are described in Chapter 6.

Parameters:

POWER	Channel power measurement (TD-SCDMA forward standard) with predefined settings
ACLR	Adjacent channel power measurement (TD-SCDMA forward standard) with predefined settings
ESPectrum	Check of signal power (spectrum emission mask)

OBANdwith OBWidth	Measurement of occupied bandwidth
PVTime	Measurement of power versus time
CDPower	Code domain analyzer measurement
CCDF	Signal statistic measurements
MCAClr	Multi Carrier Adjacent Channel Leakage Power Ratio

Example:

```

INST:SEL BTDS
'Activate TD-SCDMA BTS

INIT:CONT OFF
'Select single sweep

CONF:CDP:MEAS POW
'Select channel power measurement

INIT;*WAI
'Start measurement with synchronization

```

Characteristics:

*RST value: CDPower
 SCPI: instrument-specific

CONFigure:CDPower[:BTS]:CTABLE:MSHift 2 | 4 | 6 | 8 | 10 | 12 | 14 | 16

This command defines the maximum number of midamble shifts in the channel table.

Example:

```

INST:SEL BTDS
'Activate TD-SCDMA BTS

CONF:CDP:CTAB:NAME 'NEW_TAB'
'Select table to edit

CONF:CDP:CTAB:MSH 14
'Sets the number of midamble shifts to

```

Characteristics:

*RST value: 16
 SCPI: instrument-specific

CONFigure:CDPower[:BTS]:CTABLE:NAME <file_name>

This command selects a channel table to edit or create. It is *not* used for analysis. In this context, see commands CONF:CDP:CTAB:STAT and CONF:CDP:CTAB:SEL.

Example:

```

INST:SEL BTDS
'Activate TD-SCDMA BTS

CONF:CDP:CTAB:NAME 'NEW_TAB'
'Select table to edit

```

Characteristics:

*RST value:
SCPI: instrument-specific

CONFigure<1>:CDPower[:BTS]:CTABLE:ORDer CODE | MIDamble

This command selects sorting of the channel table in code order or midamble order.

Characteristics:

*RST value: CODE
SCPI: instrument-specific

CONFigure<1>:CDPower[:BTS]:CTABLE:SELEct <string>

This command selects a predefined channel table file. Before using this command, you must have enabled the *RECENT* channel table by the `CONF:CDP:CTAB ON` command.

Example:

```
INST:SEL BTDS
'Activate TD-SCDMA BTS meaning 'CDP relative on screen A and Result
Summary active on screen B

INIT:CONT OFF
'Select single sweep

INIT;*WAI
'Start measurement with synchronization so that channel table can be enabled

CONF:CDP:CTAB ON
'Use predefined channel table

CONF:CDP:CTAB:SEL 'CTAB_1'
'Select channel table

INIT;*WAI
'Start measurement with 'synchronization
```

Characteristics:

*RST value: RECENT
SCPI: instrument-specific

CONFigure<1>:CDPower[:BTS]:CTABLE[:STATe] ON | OFF

This command enables and disables the channel table. Enabling results in the measured channel table being saved as *RECENT* and enabled. After the *RECENT* channel table is enabled, another channel table can be selected with the `CONF:CDP:CTABLE:SELEct` command.

Note:

You must always enable the RECENT channel table first with the `CONF:CDP:CTAB:STAT` command and then use the `CONF:CDP:CTAB:SELEct` command to select the channel table you require

Example:

```

INST:SEL BTDS
'Activate TD-SCDMA BTS meaning CDP relative on screen A and Result
Summary active on screen B

INIT:CONT OFF
'Select single sweep

INIT;*WAI
'Start measurement with synchronization so that channel table can be enabled

CONF:CDP:CTAB ON
'Use predefined channel table

CONF:CDP:CTAB:SEL 'CTAB_1'
'Select channel table

INIT;*WAI
'Start measurement with
'synchronization

```

Characteristics:

*RST value: OFF
 SCPI: instrument-specific

CONFigure:CDPower:BTS:PVTime:HDYnamic ON|OFF

This command selects the high dynamic mode. The sweep mode is automatically set to single sweep.

Example:

```

INST:SEL BTDS
'Activate TD-SCDMA BTS

CONF:CDP:MEAS PVT
'Select Power Vs Time

CONF:CDP:PVT:HDYN ON
'Switch on high dynamic

```

Characteristics:

*RST-Wert: OFF
 SCPI: instrument-specific

CONFigure:CDPower[:BTS]:PVTime:SFRames

This command defines the number of subframes for averaging..

Example:

```

INST:SEL BTDS
'Activate TD-SCDMA BTS

CONF:CDP:MEAS PVT
'Select Power Vs Time

```

```
CONF:CDP:PVT:SFR 50
'Set number of subframes
```

Characteristics:

```
*RST value: 100
SCPI: instrument-specific
```

CONFigure:CDPower[:BTS]:PVTime:SPOint 1...7

This command sets the switching point between uplink and downlink slots..

Example:

```
INST:SEL BTDS
'Activate TD-SCDMA BTS

CONF:CDP:MEAS PVT
'Select Power Vs Time

CONF:CDP:PVT:SPO 6
'Set switching point
```

Characteristics:

```
*RST value: 3
SCPI: instrument-specific
```

7.6 INSTRument subsystem

The INSTRument subsystem selects the operating mode of the unit either by text parameters or by permanently assigned numbers.

INSTRument:NSElect 1 | 17

This command toggles between the operating modes by numbers.

Parameters:

```
1: spectral analysis mode
17: TD-SCDMA FWD (BTS) mode
```

Example:

```
INST:NSEL 17
'Activate TD-SCDMA BTS
```

Characteristics:

```
*RST value: 1
SCPI: compliant
```

INSTrument[:SElect] SANalyzer | ADEMod | MGSM | BWCDpower | WCDPower | BTDScdma

This command toggles between the operating modes by text parameters.

TD–SCDMA BTS (BTDS) sets the unit to a defined status. The preset values are explained in Chapter 2, section Basic settings in TD–SCDMA BTS mode.

Example:

```
INST BTDS
'Activate TD–SCDMA BTS
```

Characteristics:

*RST value: SANalyzer
SCPI: compliant

7.7 SENSE:CDPower subsystem

This subsystem sets the parameters for code domain measurement mode. The numeric suffix for SENSE<1|2> is meaningless for this subsystem.

[SENSE<1|2>:]CDPower:CODE 1..16

This command selects the code number.

Example:

```
INST:SEL BTDS
'Activate TD–SCDMA BTS meaning CDP relative on screen A and Result
Summary active on screen B

INIT:CONT OFF
'Select single sweep

CDP:CODE 11
'Select code number 11

INIT;*WAI 'Start measurement with synchronization
```

Characteristics:

*RST value: 0
SCPI: instrument–specific

[SENSE:]CDPower:ICTReshold –100 dB ...0 dB

This command sets the threshold above which a channel is regarded as active. The level refers to total signal power.

Example:

```
INST:SEL BTDS
'Activate TD–SCDMA BTS meaning CDP relative on screen A and Result
Summary active on screen B
```

```

INIT:CONT OFF
'Select single sweep

CDP:ICTR -10DB
'Threshold on -10 dB

INIT;*WAI
'Start measurement with synchronization

```

Characteristics:

*RST value: -40 dB
 SCPI: instrument-specific

[SENSe:]CDPower:IQLength 2...63

This command sets the IQ capture length in multiples of slots. The range is from 2 to 63.

Example:

```

INST:SEL BTDS
'Activate TD-SCDMA BTS meaning CDP relative on screen A and Result
Summary active on screen B

INIT:CONT OFF
'Select single sweep

CDP:IQL 8
'8 slots capture length

INIT;*WAI
'Start measurement with synchronization

```

Characteristics:

*RST value: 7
 SCPI: instrument-specific

[SENSe:]CDPower:LEVel:ADJust

This command initiates automatic setting of the RF attenuation and IF gain to the level of the applied signal. The unit is put into *RF ATTEN MANUAL* mode to optimize RF attenuation and IF gain independently of each other. This mode is retained after changing from TD-SCDMA BTS mode to *SPECTRUM* mode. The query of that command (`CDP:LEV:ADJ?`) returns **PASSED** on successful level adjustment or **FAILED** if no optimum settings could be found.

Example:

```

INST:SEL BTDS
'Activate TD-SCDMA BTS meaning CDP relative on screen A and Result
Summary active on screen B

INIT:CONT OFF
'Select single sweep

```

```
CDP:LEV:ADJ
'Start automatic level setting

INIT;*WAI
'Start measurement with synchronization
```

Characteristics:

*RST value: –
 SCPI: instrument-specific

This command is an event, so it has neither an *RST value nor a poll function.

[SENSe<1|2>:]CDPower:MMAx QPSK | PSK8 | QAM16 | QAM64

This command defines the highest modulation to be considered in the automatic channel search. In low SNR environments it may be necessary to limit the channel search to lower modulations than 64QAM.

Parameter:

QPSK: Consider QPSK modulation only
 PSK8: Consider QPSK and 8PSK modulation.
 QAM16: Consider QPSK, 8PSK and 16QAM modulation
 QAM64: Consider QPSK, 8PSK, 16QAM and 64QAM modulation

Example:

```
SENS:CDP:MMAx PSK8
'assume QPSK and 8PSK modulations only for the automatic channel search
```

Characteristics:

*RST value: QAM64
 SCPI: device-specific

[SENSe:]CDPower:MSHift 2 | 4 | 6 | 8 | 10 | 12 | 14 | 16

This command sets the maximum number of midamble shifts

Example:

```
INST:SEL BTDS
'Activate TD-SCDMA BTS

CDP:MSH 10
'Maximum midamble shift of 10
```

Characteristics:

*RST value: 16
 SCPI: instrument-specific

[SENSe:]CDPower:NORMalize ON | OFF

This command enables and disables elimination of the IQ offset.

Example:

```
INST:SEL BTDS 'Activate TD-SCDMA BTS meaning CDP relative on screen A
and 'Result Summary active on screen B
```

```
INIT:CONT OFF
'Select single sweep
```

```
CDP:NORM OFF
'Elimination of IQ offset disabled
```

```
INIT;*WAI
'Start measurement with synchronization
```

Characteristics:

*RST value: OFF
SCPI: instrument-specific

[SENSe:]CDPower:QINVert ON | OFF

This command inverts the sign of the signal Q component.

Example:

```
INST:SEL BTDS
'Activate TD-SCDMA BTS meaning CDP relative on screen A and Result
Summary active on screen B
```

```
INIT:CONT OFF
'Select single sweep
```

```
CDP:QINV ON
'Enable invert Q component
```

```
INIT;*WAI
'Start measurement with synchronization
```

Characteristics:

*RST value: OFF
SCPI: instrument-specific

[SENSe:]CDPower:SBANd NORMal | INVert

This command is used to switch the left and right sideband.

Example:

```
INST:SEL BTDS
'Activate TD-SCDMA BTS meaning CDP relative on screen A and Result
Summary active on screen B
```

```
INIT:CONT OFF
'Select single sweep
```

```
CDP:SBAN INV
'Swap sidebands
```

```
INIT;*WAI
'Start measurement with synchronization
```

Characteristics:

```
*RST value:  NORM
SCPI: instrument-specific
```

[SENSe:]CDPower:SCODE 0...127

This command sets the scrambling code of the base station.

Example:

```
INST:SEL BTDS
'Activate TD-SCDMA BTS meaning CDP relative on screen A and Result
Summary active on screen B

INIT:CONT OFF'
'Select single sweep

CDP:SCOD 51
'Set scrambling code

INIT;*WAI
'Start measurement with synchronization
```

Characteristics:

```
*RST value:  0
SCPI: instrument-specific
```

[SENSe:]CDPower:SET:COUNT 1 ... 190

If the SET COUNT is set to 1 (default value), the device behaves as normal and with the command CDPower:IQLength (IQ-Capture-Length) the number of slots can be set.

For R&S FSQ the SET COUNT can be adjusted in the range of 1...190. If the SET COUNT is greater than 1 the IQ-Capture-Length will be implicitly set to 63 slots and become unavailable. The SET COUNT defines then how many SETS of 63 slots shall be captured consecutively into the IQ RAM of the R&S FSQ.

This command is only available on R&S FSQ.

Example:

```
INST:SEL BTDS
'Activate TD-SCDMA BTS meaning CDP relative on screen A and result summary
active on screen B

INIT:CONT OFF'
'Select single sweep

CDP:SET:COUN 12
'Select 12 Sets of 63 slots on R&S FSQ

INIT;*WAI
'Start measurement with synchronization
```

```

CDP:SET 2
'Select results from SET 2

TRAC? TRACE1
'Read out CDP

```

Characteristics:

*RST value: 1
 SCPI: device-specific

[SENSe:]CDPower:SET[:VALue] 0 ... (SET COUNT-1)

With this command the SET is selected for which the results are evaluated. .
 Beforehand with CDP:SET:COUN a SET COUNT value greater than 1 must be set.

This command is only available on R&S FSQ.

Example:

```

INST:SEL BTDS
'Activate TD-SCDMA BTS meaning CDP relative on screen A and result summary
active on screen B

INIT:CONT OFF
Select single sweep

CDP:SET:COUN 12
Select 12 Sets of 63 slots on R&S FSQ

INIT;*WAI
'Start measurement with synchronization

CDP:SET 2
'Select results from SET 2

TRAC? TRACE1
'Read out CDP

```

Characteristics:

*RST value: 0
 SCPI: device-specific

[SENSe:]CDPower:SLOT 0 ...IQLength-1

The command selects the slot.

Example:

```

INST:SEL BTDS
'Activate TD-SCDMA BTS meaning CDP relative on screen A and Result
Summary active on screen B

INIT:CONT OFF
'Select single sweep

CDP:SLOT 4
'Selects slot 4

```

```
INIT;*WAI
'Start measurement with synchronization
```

Characteristics:

*RST value: 0
 SCPI: instrument-specific

[SENSe:]CDPower:STANdard[:SElect] GPP | TSM

This command switches between the standard 3GPP and TSM. At the moment, this affects the spectrum emission mask measurement only.

Parameter:

GPP: Selects the 3GPP standard
 TSM: Selects the TSM standard

Example:

```
INST:SEL BTDS
'Activate TD-SCDMA BTS meaning CDP relative on screen A and Result
Summary active on screen B
```

```
INIT:CONT OFF
'Select single sweep
```

```
CDP:STAN TSM
'Set TSM mode
```

```
INIT;*WAI
'Start measurement with synchronization
```

Characteristics:

*RST value: GPP
 SCPI: instrument-specific

[SENSe<1|2>:]CDPower:STSLOT ON | OFF

This command selects the phase reference to be used.

By default the R&S FS-K76 determines the phase reference for all downlink data slots from the downlink pilot channel (DwPCH). For e.g. beamforming or repeater measurements it might be necessary to apply different phase offsets to each time slot. Using the DwPCH as phase reference leads to rotated constellation diagrams and bad EVM values in these time slots.

By activating the new setting 'SYNC TO SLOT' the R&S FS-K76 determines the phase reference from the midamble of the selected slot. Thus the data slots can be phase rotated to each other without degrading the EVM results. The selected slot must contain at least one data channel with sufficient power for successful synchronization.

Parameter:

ON: Uses the selected slot as phase reference
 OFF: Uses the downlink pilot channel (DwPCH) as phase reference

Example:

```
SENS:CDP:STSL ON
'Use selected slot as phase reference
```

Characteristics:

*RST value: OFF
 SCPI: device-specific

[SENSe<1|2>:]CDPower:STSLot:MODE CODE | MA

This command selects the slot synchronization mode. It is effective only if SYNC TO SLOT is activated.

If CODE is selected, the phase reference is determined by a multi-stage algorithm involving code channels and midambles. At least one code channel within the selected slot must be QPSK or 8PSK modulated.

If MA is selected, the phase reference is determined by the midamble area of the selected slot. Hence there is no requirement about the code channel modulation.

Parameters:

CODE: Uses code channels and midamble of the selected slot as phase reference
 MA: Uses the midamble of the selected slot as phase reference

Example:

```
SENS:CDP:STSL:MODE MA
'use midamble in selected slot as phase reference
```

Characteristics:

*RST value: CODE
 SCPI: device-specific

[SENSe<1|2>:]CDPower:STSLot:ROTate ON | OFF

By default the R&S FS-K76 determines one phase reference for all midambles and code channels of a data slot. If ROTATE CODE TO MA is selected (SENS:CDP:STSL:ROT ON), phase rotations between the code channels are allowed. Each code channel gets its own phase reference from the associated midamble according to section AA.2 of the standard document 3GPP TS 25.221. If the associated midamble is missing, the common phase reference is used for this code channel.

Parameter:

ON: Selects the midamble of the selected slot as phase reference.
 OFF: Selects the downlink pilot channel (DwPCH) as phase reference

Example:

```
SENS:CDP:STSL:ROT ON
```

Characteristics:

*RST value: OFF
 SCPI: device-specific

7.8 SENSE:Power subsystem

In addition to the settings available in the basic unit, the autorange and timing routines can be started and the success can be polled within this subsystem. The numeric suffix for SENSE<1|2> is meaningless for this subsystem.

[SENSe<1|2>:]POWer:ACHannel:AUTO:LTIMe

This command starts the autorange routine for the reference level. This also creates the relationship between trigger and subframe start.

Note:

Subsequent commands have to be synchronized with *WAI, *OPC or *OPC? to the end of the autorange process which would otherwise be aborted.

Example:

```
POW:ACH:AUTO:LTIM;*WAI
'starts the autorange and timing routine
```

Characteristics:

*RST value: –
 SCPI: instrument-specific

[SENSe<1|2>:]POWer:ACHannel:AUTO:LTIMe?

This command returns **PASSED,<trigger to frame in seconds>,0.000** on successful level adjustment or **FAILED,0.000,0.000** if no optimum settings could be found.

Example:

```
POW:ACH:AUTO:LTIM? 'returns PASSED, 8.002e-004, 0.000
```

Characteristics:

*RST value: –
 SCPI: device-specific

[SENSe<1|2>:]POWer:ACHannel:BANDwidth|BWIDth:ACHannel 100 Hz ... 1000 MHz

This command defines the channel bandwidth of the adjacent channel of the radio transmission system. If the bandwidth of the adjacent channel is changed, the bandwidths of all alternate adjacent channels are automatically set to the same value.

Example:

POW:ACH:BWID:ACH 30kHz 'Sets the bandwidth of all adjacent channels to '30 kHz.

Characteristics:

*RST value: 14 kHz
SCPI: instrument-specific

[SENSe<1|2>:]POWer:ACHannel:BANDwidth|BWIDth:ALTernate<1...11> 100 Hz ... 1000 MHz

This command defines the channel bandwidth of the alternate adjacent channels of the radio transmission system. If the channel bandwidth of an alternate adjacent channel (e.g. channel no. 1) is changed, the bandwidth of all the following alternate adjacent channels (e.g. channels no. 2 to 11) is automatically set to the same value.

Example:

POW:ACH:BWID:ALT 30kHz
'Sets the bandwidth of all alternate adjacent channels to 30 kHz.

POW:ACH:BWID:ALT2 60kHz
'Sets the bandwidth of all alternate adjacent channel 2 and the following to 60 kHz.

Characteristics:

*RST value: 14 kHz
SCPI: instrument-specific

[SENSe<1|2>:]POWer:ACHannel:BANDwidth|BWIDth[:CHANnel] 100 Hz ... 1000 MHz

This command sets the channel bandwidth of the radio communication system. The bandwidths of adjacent channels are not influenced by this modification (in contrast to the FSE family).

Example:

POW:ACH:BWID 30kHz
'Sets the bandwidth of the TX channel to '30 kHz.

Characteristics:

*RST value: 14 kHz
SCPI: instrument-specific

[SENSe<1|2>:]POWer:ACHannel:MODE ABSolute | RELative

This command toggles between absolute and relative adjacent channel measurement.

Example:

```
SENS:POW:ACH:MODE REL
'Switch-on the relative measurement
```

Characteristics:

*RST-Wert: ABS
SCPI: instrument-specific

[SENSe<1|2>:]POWer:ACHannel:PRESet ACPower | CPOWer | MCACpower | OBANdwidth | OBWidth | CN | CN0

This command adjusts the frequency span, the measurement bandwidths and the detector as required for the number of channels, the channel bandwidths and the channel spacings selected in the active power measurement. If necessary, adjacent-channel power measurement is switched on prior to the adjustment.

To obtain valid results, a complete sweep with synchronization to the end of the sweep must be performed after the adjustment. Synchronization is possible only in the single-sweep mode.

The result is queried with the command
CALCulate:MARKer:FUNCTion:POWer:RESult?.

The command is available only for measurements in the frequency domain (span > 0).

Example:

```
SENS:POW:ACH:PRESet ACP
'Sets the frequency span, the measurement bandwidths and the detector as required for the ACP measurement in screen A.
```

Characteristics:

*RST value: -
SCPI: instrument-specific

[SENSe<1|2>:]POWer:ACHannel:PRESet:RLEVel

This command adapts the reference level to the measured channel power.

Note:

Subsequent commands have to be synchronized with *WAI, *OPC or *OPC? to the end of the autorange process which would otherwise be aborted.

Example:

```
POW:ACH:PRESet:RLEV; *WAI
' adapts the reference level to the measured ' channel power.
```

Characteristics:

*RST value: –
 SCPI: instrument-specific

[SENSe<1|2>:]POWER:ACHannel:PRESet:RLEVel?

This command returns **PASSED** on successful level adjustment or **FAILED** if no optimum settings could be found.

Example:

```
POW:ACH:PRES:RLEV?
'returns PASSED or FAILED
```

Characteristics:

*RST value: –
 SCPI: instrument-specific

**[SENSe<1|2>:]POWER:ACHannel:REFerence:TXCHannel:AUTO
MINimum|MAXimum|LHIGhest|OFF**

This command activates the automatic selection of a transmission channel to be used as a reference channel in relative adjacent-channel power measurements.

The transmission channel with the highest power, the transmission channel with the lowest power, or the transmission channel nearest to the adjacent channels can be defined as a reference channel.

MINimum: Transmission channel with the lowest power
 MAXimum: Transmission channel with the highest power
 LHIGhest: Lowermost transmission channel for the lower adjacent channels,
 uppermost transmission channel for the upper adjacent channels
 OFF: deactivated the automatic selection of a transmission channel.

Example:

```
SENS:POW:ACH:REF:TXCH:AUTO MAX
'The transmission channel with the highest power is used as a reference channel.
```

Characteristics:

*RST value: OFF
 SCPI: instrument-specific

[SENSe<1|2>:]POWER:ACHannel:REFerence:TXCHannel:MANual 1 ... 12

This command defines a reference channel for relative ACLR measurements.

Example:

```
SENS:POW:ACH:REF:TXCH:MAN 2
'Transmission channel 2 is used as a reference.
```

Characteristics:

**RST value: 1
 SCPI: instrument-specific

[SENSe<1|2>:]POWer:ACHannel:SLOT:STARt 1 ... 7

This command allows entry of the start slot for gated sweep mode. The gated mode is on between *START SLOT* and *STOP SLOT*.

Example:

```
POW:ACH:SLOT:STAR 3
'set slot 3 as start slot
```

Characteristics:

*RST value: 4
SCPI: instrument-specific

[SENSe<1|2>:]POWer:ACHannel:SLOT:STOP 1 ... 7

This command allows entry of the stop slot for gated sweep mode. The gated mode is on between *START SLOT* and *STOP SLOT*.

Example:

```
POW:ACH:SLOT:STOP 3
'set slot 3 as stop slot
```

Characteristics:

*RST value: 6
SCPI: instrument-specific

[SENSe<1|2>:]POWer:ACHannel:SPACing[:ACHannel] 100 Hz ... 2000 MHz

This command defines the channel spacing of the adjacent channel to the TX channel. At the same time, the spacing of alternate adjacent channels 1 to 11 is set to the double or triple etc. of the entered value.

Example:

```
POW:ACH:SPAC:ACH 33kHz
'Sets the spacing between the carrier signal and
'- the adjacent channel to 33 kHz
'- the alternate adjacent channel 1 to 66 kHz
'- the alternate adjacent channel 2 to 99 kHz
```

Characteristics:

*RST value: 14 kHz
SCPI: instrument-specific

[SENSe<1|2>:]POWer:ACHannel:SPACing:ALTErnate<1...11> 100 Hz ... 2000 MHz

This command defines the spacing between the alternate adjacent channels and the TX channel. If the spacing to an alternate adjacent channel *ALTErnate<k>* is modified, the spacing to all the following alternate adjacent channels *ALTErnate<n>* is set to $(<n> + 1) / (<k> + 1)$ times the entered value.

Example:

```
POW:ACH:SPAC:ALT1 33kHz
```

'Sets the spacing between TX channel and 'alternate adjacent channel 1 to '100 kHz and 'between TX channel and alternate adjacent 'channel 2 to 150 kHz.

Characteristics:

*RST value: 40 kHz (ALT1)
 60 kHz (ALT2)
 80 kHz (ALT3)
 100 kHz (ALT4)
 120 kHz (ALT5)
 140 kHz (ALT6)
 160 kHz (ALT7)
 180 kHz (ALT8)
 200 kHz (ALT9)
 220 kHz (ALT10)
 240 kHz (ALT11)

SCPI: device-specific

[SENSe<1|2>:]POWER:ACHannel:SPACing:CHANnel<1..11> 100 Hz ... 2000 MHz

This command defines the channel spacing of the carriers. At the same time the spacing of carriers with higher channel number are set to the same value. If the spacing is equal between all carriers it is sufficient to set the spacing between carrier 1 and 2 with the command `SENS:POW:ACP:SPAC:CHAN1` or `SENS:POW:ACP:SPAC:CHAN`. If the spacing are set in ascending order individual spacing of the carriers can be set.

Example:

```
POW:ACH:SPAC:CHAN2 25kHz
```

'Sets the spacing between all carriers to 25 kHz

Characteristics:

*RST value: 20 kHz
 SCPI: instrument-specific

[SENSe<1|2>:]POWER:ACHannel:TXChannel:COUNt 1 ...12

This command select the entry of the number of carrier signals to be considered.

Example:

```
SENS:POW:ACH:TXCH:COUN 4
```

Characteristics:

*RST value: 4
 SCPI: instrument-specific

[SENSe<1|2>:]POWER:NCORrection ON | OFF

This command turns noise cancellation on and off.

If noise cancellation is on, the R&S **FSW** performs a reference measurement to determine

its inherent noise and subtracts the result from the channel power measurement result

(first active trace only).

Changing the frequency, resolution bandwidth, sweep time or reference level results in a new noise correction measurement.

Example:

```
POW:NCOR ON
'Turns on noise correction
```

Characteristics:

```
*RST value: OFF
SCPI: instrument-specific
```

7.9 TRACe subsystem

TRACe[:DATA] TRACE1 | TRACE2 | ABITstream

This command transfers trace data from the controller to the unit, the poll command reads trace data from the unit.

TRACE1, TRACE2, etc. can be read out, depending on the display.

The trace data (TRACE1 | TRACE2) are formatted as follows for the different displays:

CODE DOMAIN POWER ABSOLUTE / CODE DOMAIN POWER RELATIVE (TRACE1)

The following is output for each channel:

Code class	Code class of channel, values between 0 and 4
Code number	Code number of channel, values between 1 and 16
Level	– For <i>CODE POWER ABS</i> in dBm – For <i>CODE POWER REL</i> in dB
Power detection	0 – inactive channel 1 – active channel

Thus four values are transferred for all channels:

<Code class>, <Code number>, <Level>, <Power detection>

A maximum of 16 channels are read out, channels belonging together are read out as one channel.

Example:

The example shows the results of the poll for three active channels with the following configuration:

```
DPCH 1.16 (CC 4) -7.0 dB
DPCH 2.8 (CC 3) -7.3 dB
DPCH 3.4 (CC 2) -8.0 dB
```

```
INST:SEL BTDS
```

'Activate TD-SCDMA BTS meaning CDP relative on screen A and Result Summary active on screen B

```
INIT:CONT OFF
```

'Select single sweep

```
INIT;*WAI
```

'Start measurement with synchronization

```
TRAC? TRACE1
```

'Read out CDP relative

```
4, 1, -7.0, 1,
4, 2, -55.1, 0,
3, 2, -7.3, 1,
4, 5, -56.3, 0,
4, 6, -55.8, 0,
4, 7, -57.0, 0,
4, 8, -56.7, 0,
2, 3, -8.0, 1,
4, 13, -55.8, 0,
4, 14, -56.3, 0,
4, 15, -55.9, 0,
4, 16, -57.3, 0
```

CODE DOMAIN ERROR POWER (TRACE1)

The following is output for each channel:

Code class	Code class of channel, values between 0 and 4
Code number	Code number of channel, values between 1 and 16
Error power	in dB
Power detection	0 – inactive channel 1 – active channel

Thus four values are transferred for all channels:

<Code class>, <Code number>, <Level>, <Power detection>

An error power is output for the CDEP, so consolidation of the power values is not meaningful. The number of output codes therefore generally corresponds to the spreading factor 16.

Example:

The example shows the results of the poll for three active channels with the following configuration:

```
DPCH 1.16 (CC 4) -7.0 dB
DPCH 2.8 (CC 3) -7.3 dB
DPCH 3.4 (CC 2) -8.0 dB
```

```
INST:SEL BTDS
'Activate TD-SCDMA BTS meaning CDP relative on screen A and Result
Summary active on screen B
```

```
INIT:CONT OFF
'Select single sweep
```

```
CALC2:FEED 'XTIM:CDEP'
'Code domain error power evaluation
```

```
INIT;*WAI
'Start measurement with synchronization
```

```
TRAC? TRACE1
'Read out CDP relative
```

```
4, 1, -54.5, 1,
4, 2, -55.1, 0,
4, 3, -56.3, 1,
4, 4, -56.2, 1,
4, 5, -56.3, 0,
4, 6, -55.8, 0,
4, 7, -57.0, 0,
4, 8, -56.7, 0,
4, 9, -56.2, 1,
4, 10, -56.5, 1,
4, 11, -55.8, 1,
4, 12, -55.9, 1,
4, 13, -55.8, 0,
4, 14, -56.3, 0,
4, 15, -55.9, 0,
4, 16, -57.3, 0
```

CHANNEL TABLE (TRACE1)

The following is output for each channel:

Channel type The channel type is coded by numbers as follows:

0 = *inactive*

1 = *midamble*

2 = *DPCH*

3 = *P-CCPCH*

4 = *S-CCPCH*

5 = *FPACH*

6 = *PDSCH*

7 = *PICH*

Code class Code class of channel, values between 0 and 4

Code number Code number of channel, values between 1 and 16

Modulation type Modulation type of channel

0 = *invalid (for midamble)*

1 = *QPSK*

2 = *8PSK*

3 = *16QAM*

4 = *64QAM*

Absolute level	In dBm
Relative level	In dB
Midamble shift	Values between 1 and 16
Δ MidD1	Power offset between sum power of channels (belonging to midamble(k), only data field 1) and midamble(k) Power
Δ MidD2	Power offset between sum power of channels (belonging to midamble(k), only data field 2) and midamble(k) Power
reserved 1	Reserved for additions
reserved 2	Reserved for additions

The class specifies the spreading factor of the channel

Class 4 is the highest spreading factor (16, data rate 17.6 kbps for QPSK, data rate 26.4 kbps for 8PSK), class 0 is the lowest spreading factor (1, data rate 281.6 kbps for QPSK, data rate 422.4 kbps for 8PSK).

Thus 11 values are transferred for all channels:

<Channel type>, <Code class>, <Code number>, <Modulation type>, <Absolute level in dBm>, <Relative level in dB>, <Midamble shift>, < Δ MidD1>, < Δ MidD2>, <Reserved 1>, <Reserved 2>

In code sorting (CONF:CDP:CTAB:ORD CODE), first all midambles are output, then the control channels, and finally the data channels in ascending order of code number.

In midamble sorting (CONF:CDP:CTAB:ORD MID), first the midamble is output and then its control and data channels.

Example:

The example shows the results of the poll for three channels in common midamble allocation with the following configuration:

```

Midamble m(3) -3.0 dBm
DPCH 1.16 QPSK -7.78 dBm
DPCH 2.8 QPSK -7.78 dBm
DPCH 3.4 8PSK -7.78 dBm

INST:SEL BTDS
'Activate TD-SCDMA BTS meaning CDP relative on screen A and Result
Summary active on screen B

INIT:CONT OFF
'Select single sweep

CALC2:FEED 'XTIM:CDP:ERR:CTAB'
'Channel table evaluation

INIT;*WAI
'Start measurement with synchronization

TRAC? TRACE1
'Read out channel table

1, 0, 0, 0, -3.0, 0, 3, 0.005, 0.005, 0, 0
2 , 4, 1, 1, -7.78, -4.78, 3, 0, 0, 0, 0
2 , 3, 2, 1, -7.78, -4.78, 3, 0, 0, 0, 0

```

```

2 , 2, 3, 2, -7.78, -4.78, 3, 0, 0, 0, 0
0 , 4, 2, 1, -46.9, -43.9, 3, 0, 0, 0, 0
0 , 4, 5, 1, -46.9, -43.9, 3, 0, 0, 0, 0
0 , 4, 6, 1, -46.9, -43.9, 3, 0, 0, 0, 0
0 , 4, 7, 1, -46.9, -43.9, 3, 0, 0, 0, 0
0 , 4, 8, 1, -46.9, -43.9, 3, 0, 0, 0, 0
0 , 4, 13, 1, -46.9, -43.9, 3, 0, 0, 0, 0
0 , 4, 14, 1, -46.9, -43.9, 3, 0, 0, 0, 0
0 , 4, 15, 1, -46.9, -43.9, 3, 0, 0, 0, 0
0 , 4, 16, 1, -46.9, -43.9, 3, 0, 0, 0, 0

```

RESULT SUMMARY (TRACE2)

This command polls the measured and calculated values of code domain power analysis. The results are provided for the channel to which the code selected by the `CDPower:CODE` command belongs.

Parameters:

Global results of selected slot:

SLOT	Slot number		
PDATa	Power data fields in dBm	FERRor	Frequency error in Hz
PD1	Power data field 25.40 mm dBm	CERRor	Chip rate error in ppm
PD2	Power data field 2 in dBm	TFRame	Trigger to frame
PMIDamble	Power midamble in dBm	IQIMbalance	IQ imbalance in %
RHO	RHO	IQOFFset	IQ offset in %
MACCuracy	Composite EVM in %	ACTive	Number of active channels

PCDerror Peak code domain error in dB

Channel results:

SRATe	Data rate in kbps
CHANnel	Channel number
SFACTor	Spreading factor of channel
CDPRelative	Channel power relative in dB
CDPabsolute	Channel power absolute in dBm
EVMRms	Error vector magnitude RMS in %
EVMPeak	Error vector magnitude Peak in %

The results of *RESULT SUMMARY* are output in the following order:

```

<SLOT>, <PDATa>, <PD1>, <PD2>, <PMIDamble>, <RHO>, <MACCuracy>,
<PCDerror>, <FERRor>, <CERRor>, <TFRame>, <IQIMbalance>, <IQOFFset>,
<ACTive>, <SRATe>, <CHANnel>, <SFACTor>, <CDPRelative>, <CDPabsolute>,
<EVMRms>, <EVMPeak>, <Reserved 1>, <Reserved 2>, <Reserved 3>, <Reserved
4>

```

The results have the following meanings and units:

Global results of selected slot:

SLOT	Slot number		
PDATa	Power data fields in dBm	FERRor	Frequency error in Hz
PD1	Power data field 1 in dBm	CERRor	Chip rate error in ppm
PD2	Power data field 2 in dBm	TFRame	Trigger to frame
PMIDamble	Power midamble in dBm	IQIMbalance	IQ imbalance in %
RHO	RHO	IQOFFset	IQ offset in %
MACCuracy	Composite EVM in %	ACTive	Number of active channels
PCDerror	Peak code domain error in dB		

Channel results:

SRATe	Data rate in kbps		
CHANnel	Channel number		
SFACtor	Spreading factor of channel		
CDPRelative	Channel power relative in dB	CDPabsolute	Channel power absolute in dBm
EVMRms	Error vector magnitude RMS in %		
EVMPeak	Error vector magnitude in %		



The trigger to frame (*TFRame*) value produces a 9 if the trigger is set to *FREE RUN*.

POWER VS SLOT ABS / REL (TRACE2)

The number of returned value triples corresponds to the IQ capture length.
(See *CDPower: IQLength* command, range 2 to 63.)

POWER VS SLOT ABS: <Slot number>, <Level in dBm>, <Validity>,;

POWER VS SLOT REL: <Slot number>, <Level in dB>, <Validity>,;

Validity is coded as follows:

0 = inactive (channel not occupied)

1 = active (channel occupied)

2 = alias (code class of channel < 4, i.e. several channels belong together)

PK CODE DOM ERR and COMPOSITE EVM (TRACE2)

The number of returned value pairs corresponds to the IQ capture length.
(See *CDPower: IQLength* command, range 2 to 63.)

PK CODE DOM ERR: <Slot number>, <Level in dB>,;

COMPOSITE EVM: <Slot number>, <Value in %>,;

SYMBOL EVM (TRACE2)

The number of values depends on the spreading factor:

Spreading factor 16: 44 values Spreading factor 8: 88 values

Spreading factor 4: 176 values Spreading factor 2: 352 values

Spreading factor 1: 704 values

<Value in % symbol 0>, <Value in % symbol 1>,;

POWER VS SYMBOL (TRACE2)

The number of values depends on the spreading factor:

Spreading factor 16:	44 values	Spreading factor 8:	88 values
Spreading factor 4:	176 values	Spreading factor 2:	352 values
Spreading factor 1:	704 values		

<Value in dBm symbol 0>, <Value in dBm symbol 1>,.....;

SYMBOL CONST (TRACE2)

The number of value pairs depends on the spreading factor:

Spreading factor 16:	44 values	Spreading factor 8 :	88 values
Spreading factor 4:	176 values	Spreading factor 2:	352 values
Spreading factor 1:	704 values		

Real and imaginary parts are transferred as value pairs.

<re 0>,<im 0>,<re 1>,<im 1>.....<re n>, <im n>

COMPOSITE CONST (TRACe2):

The number of value pairs corresponds to the chip number of 704 data chips in a slot. Real and imaginary parts are transferred as value pairs:

<re chip 0>, <im chip 0>, <re chip 1>, <im chip 1>,.....;

BIT STREAM (TRACE2)

The bit stream of a channel is output. A value is output for each bit (range 0, 1), each symbol consists of two bits for QPSK channels and three bits for 8PSK channels.

The number of values depends on the spreading factor in QPSK:

Spreading factor 16:	88 values	Spreading factor 2:	704 values
Spreading factor 8:	176 values	Spreading factor 1:	1408 values
Spreading factor 4:	352 values		

In 8PSK:

Spreading factor 16:	132 values	Spreading factor 2:	1056 values
Spreading factor 8:	264 values	Spreading factor 1:	2112 values
Spreading factor 4:	528 values		

TRACe1:DATA? LIST

With this command the list evaluation results are queried in the following order:

<no>, <start>, <stop>, <rbw>, <freq>, <power abs>, <power rel>, <delta>, <limit check>, <unused1>, <unused2>

All results are float values.

no	: range number
start	: start frequency
stop	: stop frequency
rbw	: resolution bandwidth of range
freq	: frequency of peak
power abs	: absolute power in dBm of peak
power rel	: relative power in dBc (related to the channel power) of peak

delta : distance to the limit line in dB (positive indicates value above the limit, fail)
 limit check : limit fail (pass = 0, fail =1)
 unused1 : reserved (0.0)
 unused2 : reserved (0.0)

Example:

```
TRAC:DATA? LIST
```

7.10 STATus:QUEStionable:SYNC register

This register contains information on the error situation in code domain power analysis of the FS-K76 option.

It can be polled with the commands `STATus:QUEStionable:SYNC:CONDition?` and `STATus:QUEStionable:SYNC[:EVENT]?`.

Table 13: Meaning of bits in STATus:QUEStionable:SYNC register

Bit no.	Meaning
0	Not used in FS-K76 application
1	K76 Frame sync failed This bit is set when synchronization is not possible within the application. The reasons for this can be: Wrongly set frequency Wrongly set level Wrongly set scrambling code Wrongly set values for <i>INVERT Q</i> or <i>SIDEBAND INV</i> Invalid signal on input
2 to 14	Not used in the FS-K76 application.
15	This bit is always 0.

7.11 Table of softkeys with assignment of IEC/IEEE bus commands

7.11.1 MEAS key or MEAS hotkey

POWER	CONF1:CDP:MEAS POW Result poll:CALC1:MARK1:FUNC:POW:RES? CPOW
ADAPT TO SIGNAL	
AUTO LEVEL&TIME	SENS:POW:ACH:AUTO:LTIME
START SLOT	SENS:POW:ACH:SLOT:START <num_value>
STOP SLOT	SENS:POW:ACH:SLOT:STOP <num_value>
ACLR	CONFigure<1>:CDPower:MEASurement ACLR Result pollCALCulate<1>:MARKer<1>:FUNctIon:POWer:RESult? ACPower
NO: OF ADJ CHAN	SENS:POW:ACH:ACP 2
ADJUST SETTINGS	SENS:POW:ACH:PRES ACP CPOWer OBW
SWEEP TIME	SENS:SWE:TIME 1 s
NOISE CORR ON OFF	SENS:POW:NCORR ON
FAST ACLR ON OFF	SENS:POW:HSP ON
DIAGRAM FULL SIZE	-
ADAPT TO SIGNAL	
AUTO LEVEL&TIME	SENS:POW:ACH:AUTO:LTIME
START SLOT	SENS:POW:ACH:SLOT:START <num_value>
STOP SLOT	SENS:POW:ACH:SLOT:STOP <num_value>
ACLR LIMIT CHECK	CALC:LIM:ACP ON CALC:LIM:ACP:ACH:RES? CALC:LIM:ACP:ALT:RES?

EDIT ACLR LIMIT	CALC:LIM:ACP ON CALC:LIM:ACP:ACH 0dB,0dB CALC:LIM:ACP:ACH:STAT ON CALC:LIM:ACP:ACH:ABS -10dBm,-10dBm CALC:LIM:ACP:ACH:ABS:STAT ON CALC:LIM:ACP:ALT1 0dB,0dB CALC:LIM:ACP:ALT1:STAT ON CALC:LIM:ACP:ALT1:ABS -10dBm,-10dBm CALC:LIM:ACP:ALT1:ABS:STAT ON CALC:LIM:ACP:ALT2 0dB,0dB CALC:LIM:ACP:ALT2:STAT ON CALC:LIM:ACP:ALT2:ABS -10dBm,-10dBm CALC:LIM:ACP:ALT2:ABS:STAT ON
ADJ CHAN SPACING	SENS:POW:ACH:SPAC:ACH 1.6MHz SENS:POW:ACH:SPAC:ALT1 3.2MHz SENS:POW:ACH:SPAC:ALT2 4.8MHz
ACLR ABS REL	SENS:POW:ACH:MODE ABS
CHAN PWR / HZ	CALC:MARK:FUNC:POW:RES:PHZ ON OFF
POWER MODE	
CLEAR/ WRITE	CALC:MARK:FUNC:POW:MODE WRIT MAXH
MAX HOLD	
MULT CARR ACLR	CONF:CDP:MEAS MCAClr Query of results: CALC:MARK:FUNC:POW:RES? MCAC
CP/ACP CONFIG	---
NO. OF TX CHAN	SENS:POW POW:ACH:ACP 2
NO. OF ADJ CHAN	SENS:POW:ACH:TXCH:COUN 4
CHANNEL BANDWIDTH	SENS:POW:ACH:BWID:CHAN <numeric_value> SENS:POW:ACH:BWID:ACH <numeric_value> SENS:POW:ACH:BWID:ALT1.<numeric_value>
CHANNEL SPACING	SENS:POW:ACH:SPAC:CHAN <numeric_value> SENS:POW:ACH:SPAC:ACH <numeric_value> SENS:POW:ACH:SPAC:ALT1 <numeric_value> SENS:POW:ACH:SPAC:ALT2 <numeric_value>
ACP REF SETTINGS	SENS:POW:ACH:REF:TXCH:MAN1 SENS:POW:ACH:REF:TXCH:AUTO MIN SENS:POW:ACH:REF:TXCH:AUTO SENS:POW:ACH:REF:TXCH:AUTO LHIG
CP/ACP ABS REL	SENS:POW:ACH:MODE ABS

ADJUST SETTINGS	SENS:POW:ACH:PRES MCAC
ACP LIMIT CHECK	:CALC:LIM:ACP ON :CALC:LIM:ACP:ACH:RES? :CALC:LIM:ACP:ALT1..11:RES?
EDIT ACP LIMIT	:CALC:LIM:ACP ON :CALC:LIM:ACP:ACH 0dB,0dB :CALC:LIM:ACP:ACH:STAT ON :CALC:LIM:ACP:ACH:ABS -10dB,-10dBm :CALC:LIM:ACP:ACH:ABS:STAT ON :CALC:LIM:ACP:ALT1 0dB,0dB :CALC:LIM:ACP:ALT1:STAT ON
SWEEP TIME	SWE:TIM <Wert>
NOISE CORR ON OFF	SENS:POW:NCOR ON
FAST ACP ONN OFF	SENS:POW:HSP ON
FULL SIZE DIAGRAMM	:DISP:WIND1:SIZE LARG :DISP:WIND1:SIZE SMAL
POWerER MODE	:CALC:MARK:FUNC:POWer:MODE WRIT MAXH
ADAPT TO SIGNAL	SENS:POW:ACH:AUTO:LTIME SENS:POW:ACH:SLOT:START 1...7 SENS:POW:ACH:SLOT:STOP 1...7
SPECTRUM EM MASK	CONFigure:CKPower:MEASurement ESpectrum Result pollCALCulate<1>:LIMit<1>:FAIL? CALCulate<1>:MARKer<1>:FUNCTion:POWerer:RESult? CPOWerer
LIMIT LINE AUTO	:CALC:LIM:ESP:MODE AUTO
LIMIT LINE MANUAL	:CALC:LIM:ESP:MODE MANual :CALCul:LIM:ESP:VAL <numeric_value>

LIMIT LINE USER	<pre>:CALC:LIM1:NAME <string> :CALC:LIM1:UNIT DBM :CALC:LIM1:CONT:DATA <num_value>, <num_value>, ... :CALC:LIM1:CONT:DOM FREQ :CALC:LIM1:CONT:TRAC 1 :CALC:LIM1:CONT:OFF <num_value> :CALC:LIM1:CONT:MODE REL :CALC:LIM1:UPP:DATA <num_value>, <num_value>.. :CALC:LIM1:UPP:STAT ON OFF :CALC:LIM1:UPP:OFF <num_value> :CALC:LIM1:UPP:MARG <num_value> :CALC:LIM1:UPP:MODE ABS :CALC:LIM1:UPP:SPAC LINear</pre> <p>Notes:</p> <ul style="list-style-type: none"> - If the Y values are entered with the command CALC:LIM<1>:LOW[:DATA], the limit check is failed if the values are below the limit line. - If a user-defined limit line is enabled, this has priority over limit lines selected with AUTO or MANUAL.
RESTORE STD LINES	:CALC:LIM:ESP:REST
ADAPT TO SIGNAL	
AUTO LEVEL&TIME	SENS:POW:ACH:AUTO:LTIME
START SLOT	SENS:POW:ACH:SLOT:START <num_value>
STOP SLOT	SENS:POW:ACH:SLOT:STOP <num_value>
OCCUPIED BANDWIDTH	<pre>CONF1:CDPower:MEAS OBAN Result poll: CALC1:MARK1:FUNC:POW:RES? OBAN</pre>
% POWERER BANDWIDTH	SENS:POW:BWID 99PCT
ADJUST SETTINGS	SENS:POW:PRES OBW
ADAPT TO SIGNAL	
AUTO LEVEL&TIME	SENS:POW:ACH:AUTO:LTIM
START SLOT	SENS:POW:ACH:SLOT:START <num_value>
STOP SLOT	SENS:POW:ACH:SLOT:STOP <num_value>
POWER VS TIME	<pre>CONF:CDP:MEAS PVT Result poll: CALC1:LIM1:FAIL?</pre>
SWITCHING POINT	CONF:CDP:PVT:SPO <num_value>

RESTORE STD LINES	CALC:LIM:PVT:REST
NO OF SUBFRAMES	CONF:CDP:PVT:SFR <num_value>
AUTO LEVEL&TIME	SENS:POW:ACH:AUTO:LTIM
CODE DOM ANALYZER	CONF:CDP:MEAS CDP
SIGNAL STATISTIC	CONF:CDP:MEAS CCDF or CALC:STAT:BTS:CCDF:STAT ON Result Poll: CALC:MARK:X?
APD	CALC:STAT:APD ON
CCDF	CALC:STAT:CCDF ON
PERCENT MARKER	CALC:MARK:Y:PERC 0...100%
NO OF SAMPLES	CALC:STAT:NSAM <value>
SCALING	
X-AXIS REF LVL	CALC:STAT:SCAL:X:RLEV <value>
X-AXIS RANGE	CALC:STAT:SCAL:X:RANG <value>
X-AXIS MAX VALUE	CALC:STAT:SCAL:Y:UPP <value>
X-AXIS MIN VALUE	CALC:STAT:SCAL:Y:LOW <value>
ADJUST SETTINGS	CALC:STAT:SCAL:AUTO ONCE
DEFAULT SETTINGSL	CALC:STAT:PRES
ADAPT TO SIGNAL	
AUTO LEVEL&TIME	SENS:POW:ACH:AUTO:LTIM Result poll: SENS:POWer:ACH:AUTO:LTIM?
START SLOT	SENS:POW:ACH:SLOT:START <num_value>
STOP SLOT	SENS:POW:ACH:SLOT:STOP <num_value>
CONT MEAS	INIT:CONT ON; INIT:IMM
SINGLE MEAS	INIT:CONT OFF; INIT:IMM

7.11.2 RESULTS hotkey or CODE DOM ANALYZER softkey

CODE DOM POWerER	CALC1:FEED XPOW:CDP:RAT (relative) CALC1:FEED XPOW:CDP (absolute)
CODE DOM ERROR	CALC1:FEED XPOW:CDEP
COMPOSITE EVM	CALC1:FEED XTIM:CDP:MACCuracy
PK CODE DOM ERR	CALC2:FEED XTIM:CDP:ERR:PCD
POWerER VS SLOT:	CALC2:FEED XTIM:CDP:PVSL:RAT (relative) CALC2:FEED XTIM:CDP:PVSL:ABS (absolute)
RESULT SUMMARY	CALC2>:FEED XTIM:CDP:ERR:SUMM Poll result: CALC1:MARKer1:FUNC:CDP:BTS:RES? SLOT PDAT PD1 PD2 PMID RHO MACC PCD FERR CERR TFR IQIMB IQOF ACT SRAT CHAN SFAC CDPR CDP EVMR EVMP
SELECT CHANNEL	[SENSe:]CDP:CODE 0..0.15
SELECT SLOT	[SENSe:]CDP:SLOT 0 ... (IQ_CAPTURE_LENGTH-1)
ADJUST REF LVL	SENS:POW:ACH:PRES:RLEV
CHANNEL TABLE	CALC1:FEED XTIM:CDP:ERR:CTAB
CH TABLE CODE	CONF:CDP:CTAB:ORD CODE
CH TABLE MIDAMBLE	CONF:CDP:CTAB:ORD MID
SYMBOL CONST	CALC2:FEED XTIM:CDP:SYMB:CONS
SYMBOL EVM	CALC2:FEED XTIM:CDP:SYMB:EVM
BIT STREAM	CALC2:FEED XTIM:CDP:BSTReam
COMPOSITE CONST	CALC2:FEED XTIM:CDP:COMP:CONS

POWERER VS SYMBOL	CALC>:FEED XTIM:CDP:PVSY
SELECT	
CAPTURE LENGTH	SENS:CDP:IQLength 2..63
SET COUNT	SENS:CDP:SET:COUNT 1..190 (nur R&S FSQ)
SET TO ANALYZE	SENS:CDP:SET:[VALue] 0..(SET COUNT-1) (nur R&S FSQ)
SELECT CHANNEL	SENS:CDP:CODE 0...16
SELECT SLOT	SENS:CDP:SLOT 0 ... (IQ_CAPTURE_LENGTH-1)
SELECT CHANNEL	SENS:CDP:CODE 1...16
SELECT SLOT	SENS:CDP:SLOT 0 ... (IQ_CAPTURE_LENGTH-1)
ADJUST REF LVL	SENS:POW:ACH:PRES:RLEV

7.11.3 CHAN CONF hotkey

CODE CHAN AUTOSEARCH	CONF:CDP:BTS:CTAB:STAT OFF
CODE CHAN PREDEFINED	CONF:CDP:BTS:CTAB1:STAT ON CONF:CDP:BTS:CTAB:SEL <channel table name>
EDIT CHAN CONF TABLE	---
NEW CHAN CONF TABLE	---
HEADER VALUES	CONF:CDP:BTS:CTAB:NAME NEW_TAB CONF:CDP:BTS:CTAB:DATA <numeric>,... CONF:CDP:BTS:CTAB:COMM comment CONF:CDP:BTS:CTAB:MSH <numeric> CONF:CDP:BTS:CTAB:CAT?
ADD SPECIAL	---
INSERT LINE	---
DELETE LINE	---
MEAS CHAN CONF TABLE	---
SAVE TABLE	---
SELECT SLOT	SENS:CDP:SLOT 0 ... (IQ_CAPTURE_LENGTH-1)
SORT CODE	---
SORT MIDAMBLE	---
DEL CHAN CONF TABLE	CONF:CDP:BTS:CTAB:DEL
COPY CHAN CONF TABLE	CONF:CDP:BTS:CTAB:COPY CTAB2

7.11.4 SETTINGS hotkey

STANDARD 3GPP TSM	SENS:CDP:STAN GPP TSM
SCRAMBLING CODE	SENS:CDP:SCOD 0..127
MA SHIFTS CELL	SENS:CDP:MSH 2 4 6 8 10 12 14 16
CAPTURE SETTINGS	
CAPTURE LENGTH	SENS:CDP:IQL 2..63
SET COUNT	SENS:CDP:SET:COUN 1..190 (only R&S FSQ)
SET TO ANALYZE	SENS:CDP:SET:[VALue] 0..(SET COUNT-1) (nur R&S FSQ)
SELECT CHANNEL	SENS:CDP:CODE 0...16
SELECT SLOT	SENS:CDP:SLOT 0 ... (IQ_CAPTURE_LENGTH-1)
INACT CHAN THRESHOLD	SENS:CDP:ICTR -100 dB ... 0 dB
CODE PWR ABS REL	CALC1:FEED XPOW:CDP:RAT (relative) CALC1:FEED XPOW:CDP (absolute) CALC2:FEED XTIM:CDP:PVSL:RAT (relative) CALC2:FEED XTIM:CDP:PVSL:ABS (absolute)
INVERT Q ON OFF	SENS:CDP:QINVert ON OFF
SIDE BAND NORN INV	SENS:CDP:SBAND NORM INV
NORMALIZE ON OFF	SENS:CDP:NORM ON OFF
SYNC TO SLOT	SENS:CDP:STSL ON OFF
ROTATE CODE TO MA	SENS:CDP:STSL:ROT ON OFF

8 Checking Rated Specifications

- Power off the analyzer before removing or inserting modules.
- Before powering the unit on, check the position of the line voltage selector (230 V).
- Measure the rated specifications after a warm up time of at least 30 min and completion of system error correction of the analyzer and the R&S SMIQ. This is the sole way of ensuring that rated specifications are maintained.
- Unless otherwise specified, all settings are made proceeding from the PRESET setting.

The following conventions apply to settings on the analyzer during measurement:

[<KEY>] Press a key on the front panel, e.g. [FREQ].

[<SOFTKEY>] Press a softkey, e.g. [MARKER → PEAK].

[<nn unit>] Enter a value + terminate the entry with the unit, e.g. [12 kHz].

- The values in the following sections are not guaranteed. Only the specifications of the data sheet are binding.

8.1 Measuring equipment and accessories

Item	Instrument type	Recommended characteristics	Recommended equipment	R&S order no.
1	Signal generator	Vector signal generator	R&S SMIQ with options: SMIQB20 SMIQB11 SMIQB60 SMIQK14 SMIQ-Z5 PARADATA	1125.5555.xx 1125.5190.02 1085.4502.04 1136.4390.02 1105.1383.02 1104.8555.02
2	Controller for generating signals with R&S WinIQSIM A PC that is either connected to the R&S SMIQ by a serial cable or has an IEC/IEEE bus card and is connected to the R&S SMIQ by an IEC/IEEE bus cable. Installed on this PC is the R&S WinIQSIM Software 4.00 or higher. This software can be downloaded from the Rohde & Schwarz Internet site .			

8.2 Test sequence

The performance test refers exclusively to results of the code domain analyzer.

There is no need to check the results of POWERER, ACLR and SPECTRUM measurements, since they are already covered by the performance test of the basic unit.

If you have not already done so, first generate the WinIQSIM file with the TD-SCDMA signal and transfer it to the R&S SMIQ under the name TDS_BS. This is explained in Chapter "Generating TD-SCDMA signal with R&S WinIQSIM."

Default settings on R&S SMIQ:	[PRESET]	
	[LEVEL:	0 dBm]
	[FREQ:	2020.0 MHz]
	ARB MOD	
	SET SMIQ ACCORDING TO WAVEFORM ...	
	SET SMIQ ACCORDING TO WAVEFORM ...	ON
	TRIGGER OUT MODE	ON
	<i>(These settings are only needed once after presetting the generator and serve for automatically adopting the trigger setting from the waveform file generated by R&S WinIQSIM in ARB MOD. This is especially convenient when changing between different waveforms.)</i>	
	SELECT WAVEFORM...	Select name 'TDS_BS'
	STATE:	ON
Default settings on analyzer:	[PRESET]	
	[CENTER:	2020.0 MHz]
	[AMPT:	10 dBm]
	[TDS BS]	
	[TRIG	EXTERN]
	[RESULTS	SELECT SLOT 4]
	[RESULTS	CHANNEL TABLE]
Test setup and other settings:	▶	Connect the RF output of the R&S SMIQ to the RF input of the analyzer.
	▶	Connect the external trigger input of the analyzer to the TRIG1 port of the Z5 PARADATA BNC Adapter.
	▶	Connect the external reference output of the analyzer to the R&S SMIQ.
R&S SMIQ	UTILITIES	
	REF OSC	
	SOURCE:	EXT
Analyzer	[SETUP:	REFERENCE EXT]

The measurement result displayed on the screen of the analyzer should now be as follows:



BS, TDS: CHANNEL TAB

		CF 2 GHz		Chan 1.16		Slot 4				
	Type	Chan.SF	Data Rate	Mod Type	Pwr.Abs dBm	Pwr.Rel dB	MA.shift	ΔMiD1 dB	ΔMiD2 dB	
Ref	Midamble	---	---	---	-1.17	0.00	8	0.00	0.00	A
9.00	DPCH	1.16	17.60	QPSK	-10.21	-9.04	8	---	---	
dBm	DPCH	2.16	17.60	QPSK	-10.19	-9.02	8	---	---	
Att	DPCH	3.16	17.60	QPSK	-10.20	-9.03	8	---	---	TRG
35 dB	DPCH	4.16	17.60	QPSK	-10.20	-9.03	8	---	---	
	DPCH	5.16	17.60	QPSK	-10.21	-9.04	8	---	---	
	DPCH	6.16	17.60	QPSK	-10.20	-9.03	8	---	---	
1	DPCH	7.16	17.60	QPSK	-10.20	-9.03	8	---	---	
CLRWR	DPCH	8.16	17.60	QPSK	-10.20	-9.02	8	---	---	
	---	9.16	---	---	-51.90	-50.73	--	---	---	

PRN

RESULT SUMMARY TABLE

DR 17.6 kbps

Chan 1.16

CF 2 GHz

Slot 4

		GLOBAL RESULTS		
Ref	Chip Rate Error	1.54 ppm	Trg to Frame	82 ns
	SLOT RESULTS			
9.00	P Data	-1.17 dBm	Carr Freq Err	-2.72 kHz
dBm	P D1	-1.17 dBm	IQ Imbal/Offs	0.03/0.22 %
Att	P D2	-1.17 dBm	RHO	0.9999
35 dB	P Midamble	-1.17 dBm	Composite EVM	1.21 %
	Active Channels	8	Pk CDE(SF 16)	-49.30 dB
	CHANNEL RESULTS			
1	Channel.SF	1.16	Data Rate	17.6 kbps
CLRWR	ChannelPwr Rel	-9.04 dB	ChannelPwr Abs	-10.21 dBm
	Symbol EVM	0.72 %rms	Symbol EVM	1.27 %Pk

B

9 Glossary

CDEP

Code domain error power

CDP

Code domain power

Composite EVM

According to 3GPP2 specifications, the square root of the squared error between the real and the imaginary parts of the test signal and an ideally generated reference signal is determined (EVM referred to the total signal) in composite EVM measurement

Crest factor

Ratio of peak to average value of the signal

Inactive channel threshold

Minimum power that a single channel must have compared with the total signal to be identified as an active channel

Midamble shift

Number for a segment of a basic midamble

P-CCPCH

Primary common control physical channel

RRC filter

Root raised cosine filter, for TD-SCDMA with roll off of 0.22

S-CCPCH

Secondary common control physical channel

SF

Spreading factor

x, y

Channel number x.y, where:
x is the code number,
y is the spreading factor of the channel

10 Index

ACLR.....	31
Active Channels.....	72
Adjacent channel power.....	31
number of channels.....	33
Amplitude power distribution.....	57, 59
Amplitude probability distribution function.....	57, 59
Attenuation	
mechanical.....	95
Average.....	101
Bit stream.....	76
Carr Freq Err.....	72
CCDF	
complementary cumulative distribution function.....	57, 59
Center frequency.....	93
Chan.SF.....	74
Channel	
power.....	42
active.....	90
number.....	33
spacing.....	37
Channel number.....	84
Channel occupancy table.....	73
Channel power.....	28
absolute/relative.....	38
Channel Power Abs.....	73
Channel Power Rel.....	73
Channel SF.....	73
Channel type.....	84
Checking rated specifications.....	149
Chip Rate Error.....	72
Code domain error power.....	68
Code domain power.....	67
Commands	
assignment to softkey.....	140
Complementary distribution function.....	59
Composite constellation.....	77
Composite EVM.....	72
Data rate.....	84
Data Rate.....	73, 74
Default setting.....	14
Distribution function.....	59
Distribution function of signal amplitudes.....	57, 59
Fast power measurement.....	35
Frequency	
offset.....	94
Funktionsfelder.....	66
Grenzwert	
ACP-Messung.....	36
Hotkey	
CHAN CONF.....	24, 81
EXIT TDS.....	25
MEAS.....	25, 27
RESULTS.....	24, 65
SETTINGS.....	24, 88
TDS BS.....	24
IQ Imbal/Offs.....	72
Key	
AMPT.....	94
BW.....	99
CAL.....	102
DISP.....	102
FILE.....	102
FREQ.....	93
HCOPY.....	102
MARKER.....	96
MEAS.....	27, 99
MKR FCTN.....	98
MKR→.....	97
PRESET.....	102
SETUP.....	102
SPAN.....	94
SWEEP.....	99
TRACE.....	100
TRIG.....	99
Limit	
probability range.....	60
Limit check	
ACLR measurement.....	36
Ma Shift.....	75
Marker	
maximum.....	97
Max Hold.....	100
Maximum search.....	97
Menü-Übersicht.....	24
Messaufbau.....	22
Midamble Shift.....	84
Min Hold.....	100
Mod Type.....	75
Offset	
frequency.....	94
Overwrite mode.....	100
P Data.....	72
P Midamble.....	72
PD1/PD2.....	72
Peak code domain error.....	70
Peak value detection.....	100
Performance test.....	149
Pk CDE.....	72
Power	
ref. to 1 Hz bandwidth.....	38
TD-SCDMA signal.....	44
Power bandwidth	
percentage.....	53
Power measurement	
Fast.....	35
Power versus symbol.....	78
Preset.....	14
Pwr Abs/Pwr Rel.....	75
Rated specifications.....	149
RCDE.....	73
Reference level.....	94
Referenzpegel.....	94

Remote control	103	DELETE LINE.....	85
RF attenuation		DIAGRAM FULL SIZE.....	36
mechanical	95	EDIT ACLR LIMIT.....	36
RHO	72	EDIT CHAN CONF TABLE.....	82, 114
Scaling.....	60	FAST ACLR ON / OFF.....	35
Search		FREQUENCY OFFSET.....	94
maximum.....	97	HEADER / VALUES.....	83
Signal amplitudes, distribution function	57, 59	HEADER/VALUES.....	114
Signal statistic.....	57, 59	HIGH DYNAMIC.....	57, 116
Slot.....	80, 90	INACT CHAN THRESHOLD.....	90, 118
Softkey		INSERT LINE.....	85
% POWER BANDWIDTH	53	INVERT Q.....	121
ACLR.....	27, 31, 113	INVERT Q ON / OFF.....	91
ACLR ABS / REL.....	38	LIMIT LINE AUTO.....	45, 105
ACLR LIMIT CHECK	36, 39, 113	LIMIT LINE MANUAL.....	46, 105
ACP REF SETTINGS	41	LIMIT LINE USER.....	48, 105
ACP REF SETTINGS.....	129	LIST EVALUATION.....	49, 110
ADAPT TO SIGNAL.....	30, 36, 49, 54, 62	MA SHIFTS CELL.....	120
ADD SPECIAL.....	84, 112	MA SHIFTS CELL.....	89
ADJ CHAN SPACING.....	37	MARKER 1..4.....	107
ADJUST REF LEVEL.....	95, 119	MARKER 1-4.....	96
ADJUST REF LVL.....	80, 128	MARKER NORM / DELTA.....	96
ADJUST SETTINGS.....	53, 61	MARKER NORM/DELTA.....	107
ADJUST SETTINGS (power measurements).....	42, 128	MAX HOLD.....	100
ALL MARKER OFF.....	96	MEAS CHAN CONF TABLE.....	85
APD ON/OFF.....	59	MIN HOLD.....	100
AUTO LEVEL & TIME.....	30, 36, 50, 54, 57, 62	MULT CARR ACLR.....	39
AUTO LEVEL&TIME.....	126	NEW CHAN CONF TABLE.....	87, 114
AVERAGE.....	101	NEXT MODE LEFT / RIGHT.....	98
BIT STREAM.....	76, 132	NEXT PEAK.....	98
BITSTREAM.....	103	NO OF SAMPLES.....	59
CAPTURE LENGTH.....	69, 70, 71, 79, 89, 119	NO OF SUBFRAMES.....	116
CAPTURE SETTINGS.....	89	NO. OF ADJ CHAN.....	33
CCDF ON/OFF.....	59, 113	NO. OF SUBFRAMES.....	56
CENTER.....	93	NO. OF TX CHAN.....	40, 131
CF STEPSIZE	93	NORMALIZE ON / OFF.....	91
CH TABLE CODE.....	115	NORMALIZE ON/OFF.....	120
CHAN PWR / HZ.....	38	OCCUPIED BANDWIDTH.....	27, 51, 113
CHAN TABLE HEADER.....	111	PEAK.....	97
CHANNEL BANDWIDTH.....	40	PEAK MODE MIN / MAX.....	98
CHANNEL BANDWIDTH.....	127	PERCENT MARKER.....	59
CHANNEL BANDWIDTH.....	127	PK CODE DOM ERR.....	70, 103, 132
CHANNEL BANDWIDTH.....	127	POWER.....	27, 28, 113
CHANNEL SPACING.....	41, 130, 131	POWER MODE.....	38, 43, 108
CHANNEL TABLE.....	73, 103, 115, 132	POWER VS SLOT.....	71, 103, 132
CLEAR / WRITE.....	100	POWER VS SYMBOL.....	78, 103
CODE CHAN AUTOSEARCH.....	81	POWER VS TIME.....	55, 113
CODE CHAN PREDEFINED.....	82, 115	REF LEVEL.....	94
CODE DOM ANALYZER.....	28, 113	REF VALUE POSITION.....	95
CODE DOM ERROR.....	68, 103	RESTORE STD LINES.....	49, 56
CODE DOM POWER.....	67, 103, 132	RESULT DISPLAY.....	103
CODE PWR ABS / REL.....	91	RESULT SUMMARY.....	72, 103, 132
CODE PWR ABS/REL.....	103	RF ATTEN AUTO.....	95
COMPOSITE CONST.....	103	RF ATTEN MANUAL.....	95
COMPOSITE CONST.....	77	SAVE TABLE.....	85
COMPOSITE EVM.....	69, 103, 132	SCALING.....	60
CONT MEAS.....	63	SCRAMBLING CODE.....	89, 122
COPY CHAN CONF TABLE.....	86, 112	SELECT.....	78
CP/ACP ABS/REL.....	42, 128	SELECT CHANNEL.....	79, 90, 118
CP/ACP CONFIG.....	40	SELECT MARKER.....	97
DEFAULT SETTINGS.....	61	SELECT SLOT.....	80, 85, 90, 123
DEL CHAN CONF TABLE.....	86, 113	SET COUNT.....	79, 89, 122

SET TO ANALYZE	79, 89, 123	X-AXIS RANGE.....	60
SIDEBAND NORM / INV.....	91, 121	X-AXIS REF LEVEL.....	60
SIGNAL STATISTIC.....	28, 57	Y PER DIV.....	95
SINGLE MEAS.....	63	Y-AXIS MAX VALUE	60
SORT CODE.....	85	Y-AXIS MIN VALUE.....	61
SORT MIDAMBLE.....	86	Special channels.....	84
SPECTRUM EM MASK.....	27, 44, 113	Spreading factor	84
STANDARD.....	45, 88, 124	Status.....	84
START MEAS.....	56	STATus	
START SLOT	62	QUESTionable	
START SLOT	31, 36, 50, 54	SYNC register	139
START SLOT	62	Symbol constellation.....	75
START SLOT	130	Symbol error vector magnitude	76
START SLOT	130	Symbol EVM.....	73
STOP SLOT	31, 36, 50, 54, 62	Symbol rate	84
SWEEP COUNT.....	101	Total power.....	38
SWEEP TIME.....	35	Trace	
SWITCHING POINT	56, 117	overwrite mode.....	100
SYMBOL CONST	103, 132	peak value detection.....	100
SYMBOL CONST.....	75	Transducer.....	102
SYMBOL EVM.....	76, 103, 132	Trg to Frame.....	72
SYNC TO SLOT	92, 124	Δ MiD1.....	75
VIEW	101	Δ MiD2.....	75